

BG ПОКРИВНИ ПРОЗОРЦИ	FR FENÊTRES DE TOIT	IT FINESTRE PER TETTI	RO GEAMURI DE ACOPERIŞ	TR çatı pencereleri
CZ STŘEŠNÍ OKNA	GB ROOF WINDOWS	MK ПРОЗОРЦИ НА ПОКРИВОТ	RU МАНСАРДНЫЕ ОКНА	
DE DACHFENSTER	GR ΠΑΡΑΘΥΡΑ ΟΡΟΦΗΣ	PL OKNA DACHOWE	SE TAKFÖNSTER	
ES VENTANA DE TEJADOS	HU TETŐTÉRI ABLAOKOK	PT JANELAS DE SÓTÃO	SK STREŠNÉ OKNÁ	

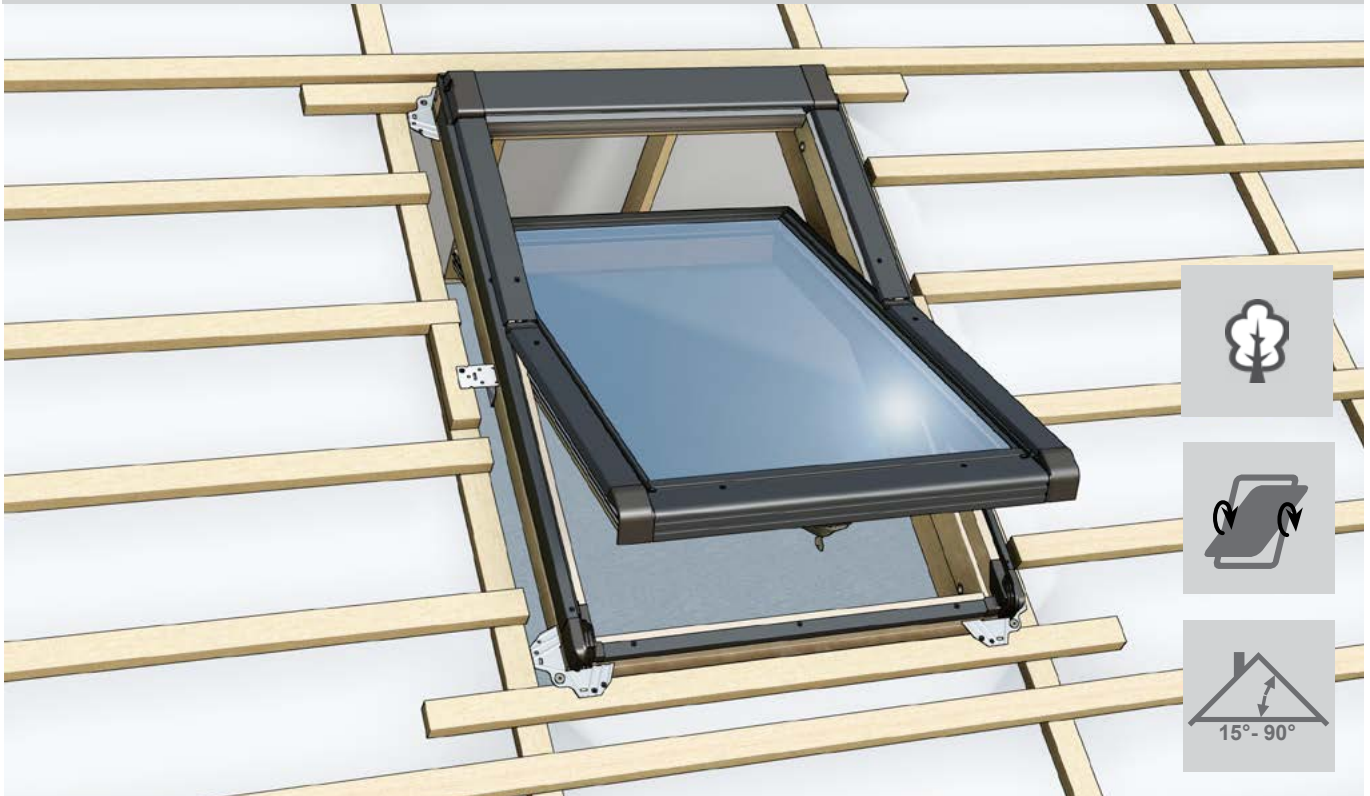

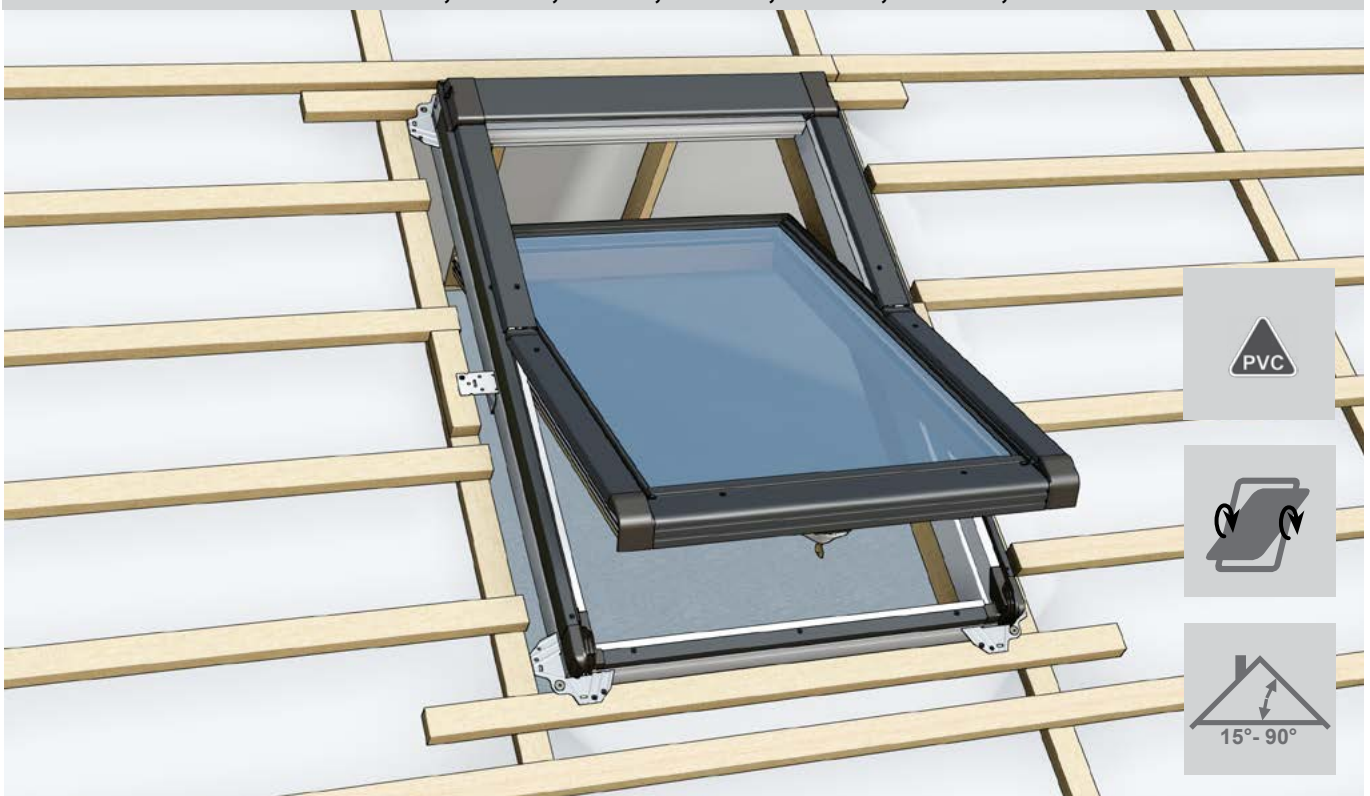



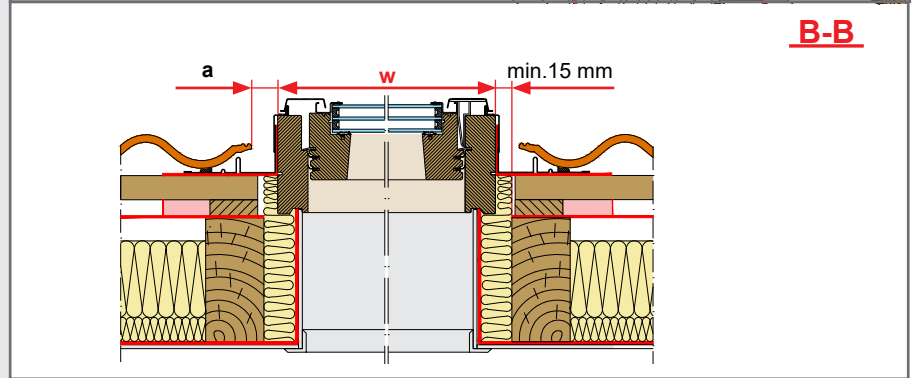
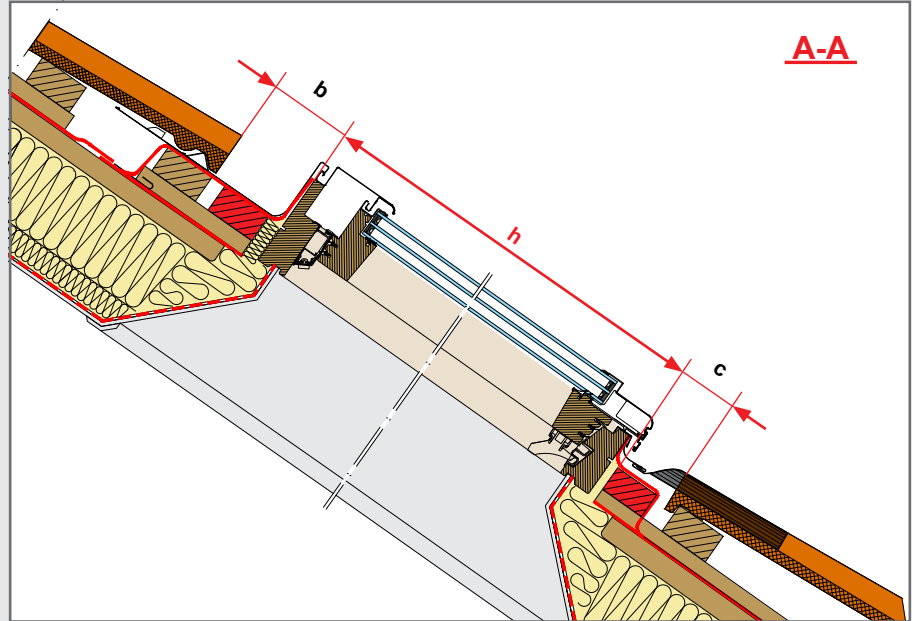
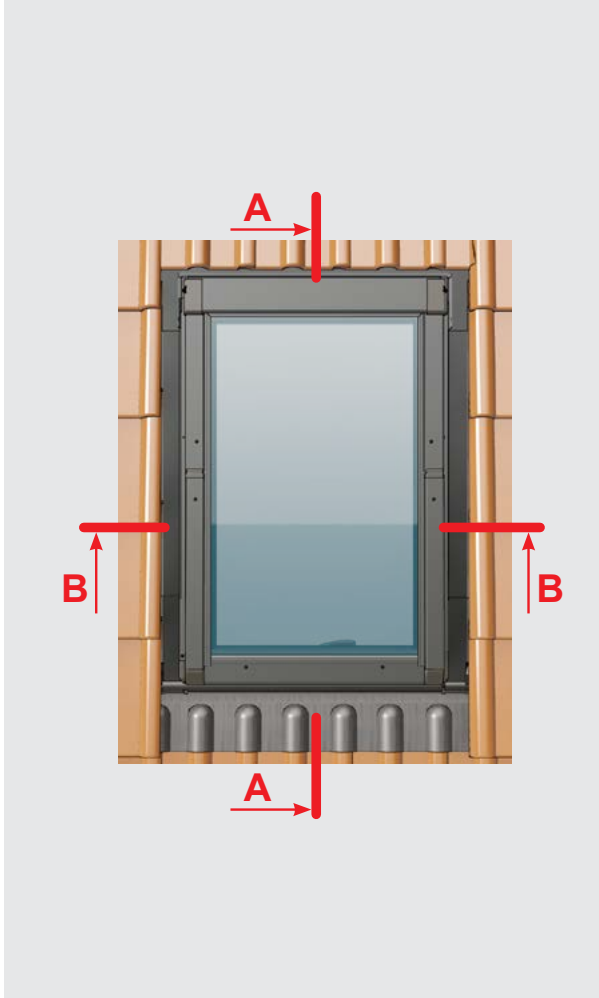
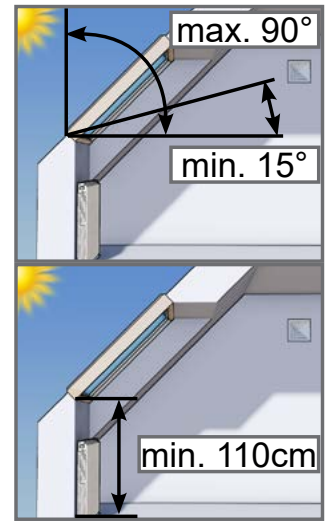
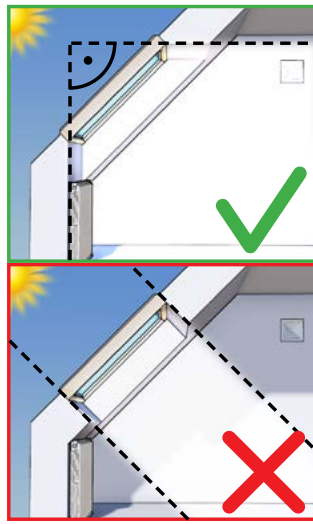
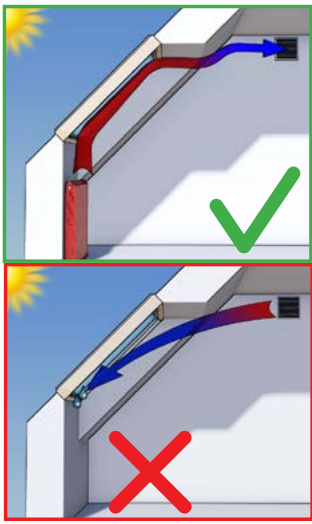

ISOV, ISOM, ISOX, VSOV, VSOM, NK, NKV, NKM,

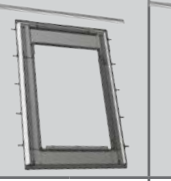
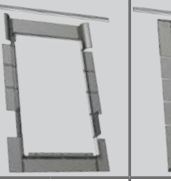
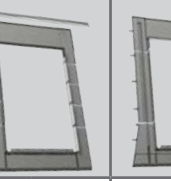
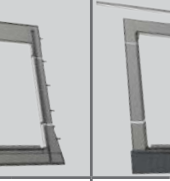
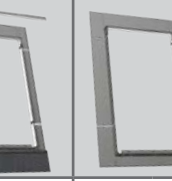

IGOV, IGOM, IGOX, BGOV, VGOV, VGOM,



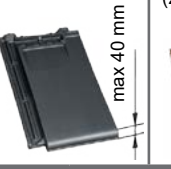
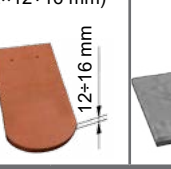
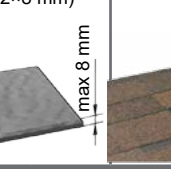
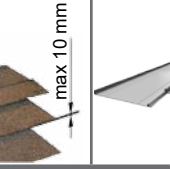
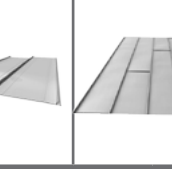

									
	H12 [mm]	H9 [mm]	H5 [mm]	D [mm]	LH [mm]	L [mm]	P [mm]	BPH9 [mm]	R [mm]
									
a	min. 30 max. 60	min. 30 max. 60	min. 30 max. 60	min. 45 max. 50	min. 45 max. 50	min. 0 max. 20	min. 45 max. 50	0 0	min. 90 max. 130
b	60 + 150	60 + 150	60 + 150	60 + 150	60 + 150	60 + 150	60 + 150	60 + 10	max 200
c	90 + 110	90 + 110	60 + 70	100 + 110	20 + 50	20 + 50	20 + 50	60+70	50+120

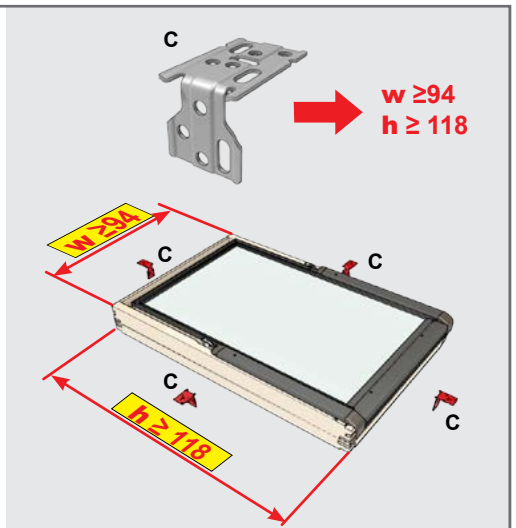
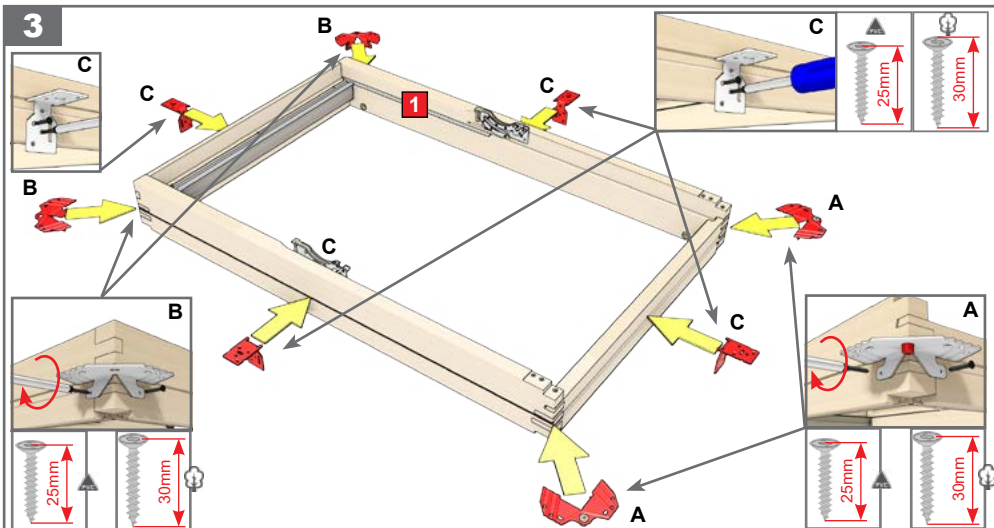
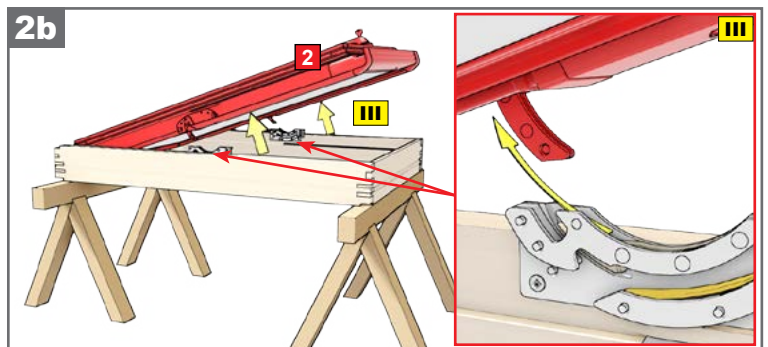
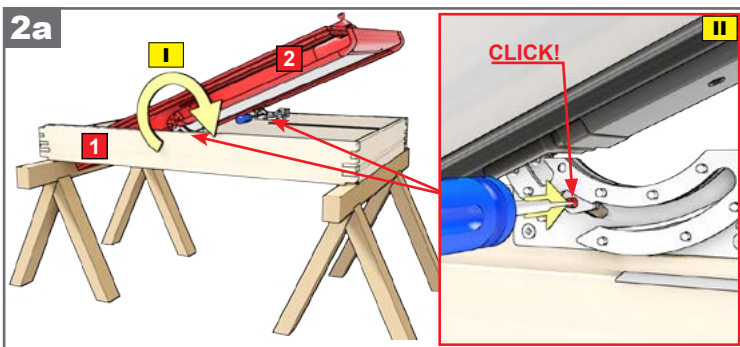
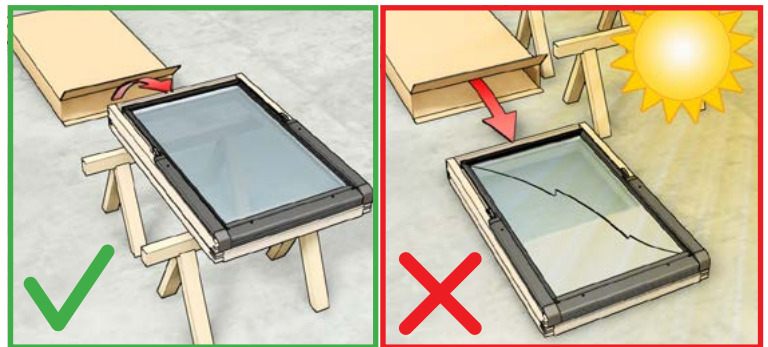
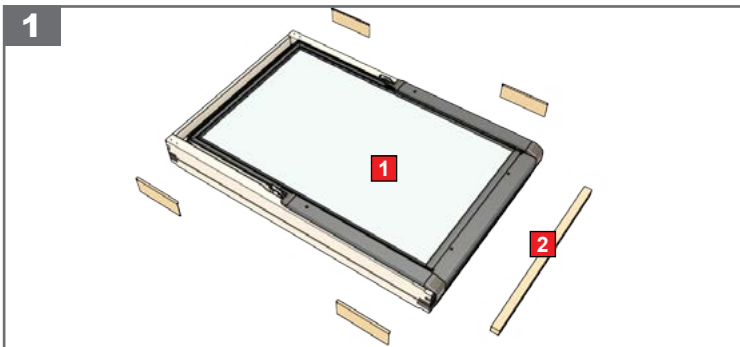
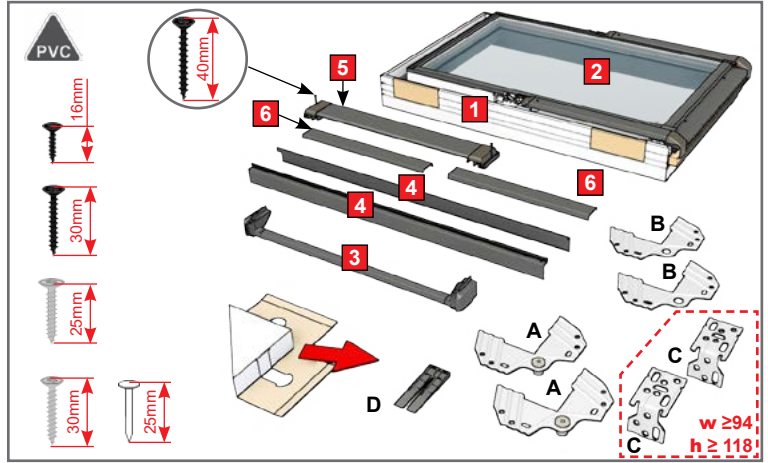
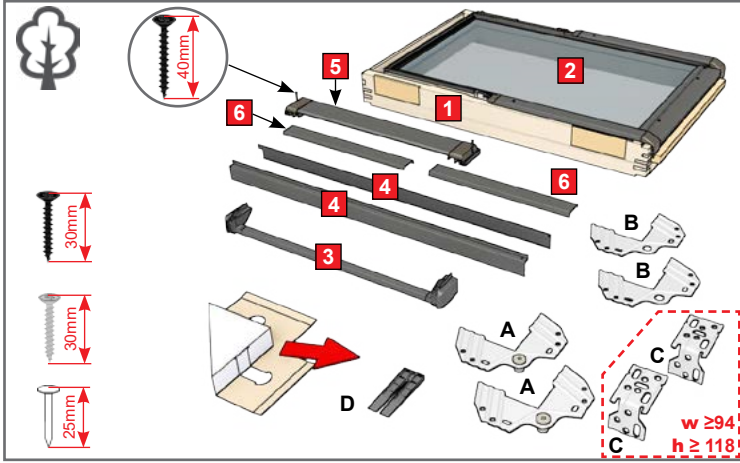
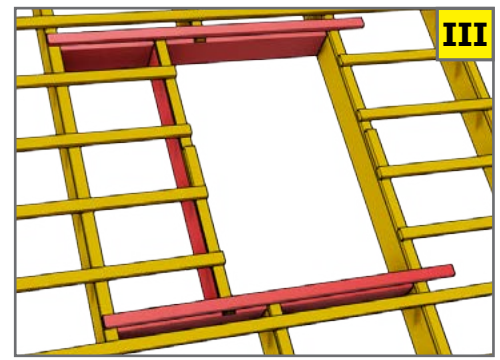
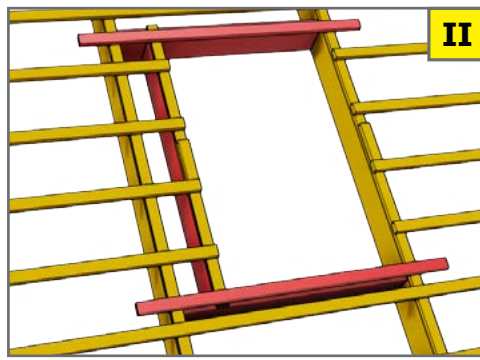
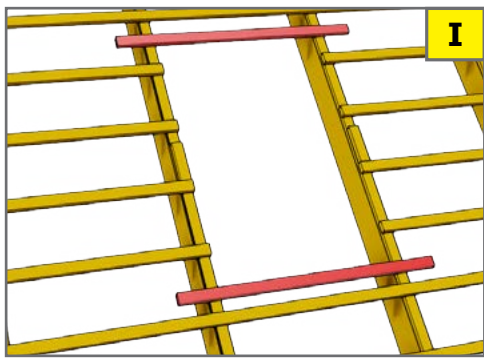

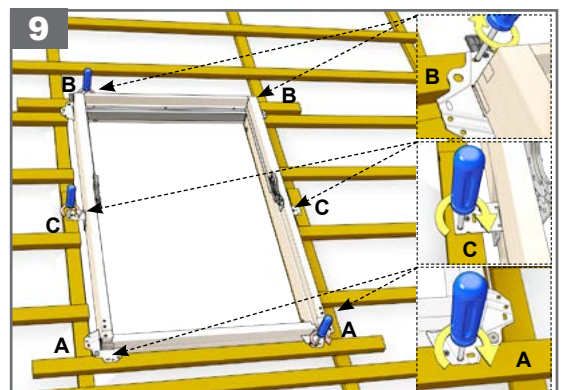
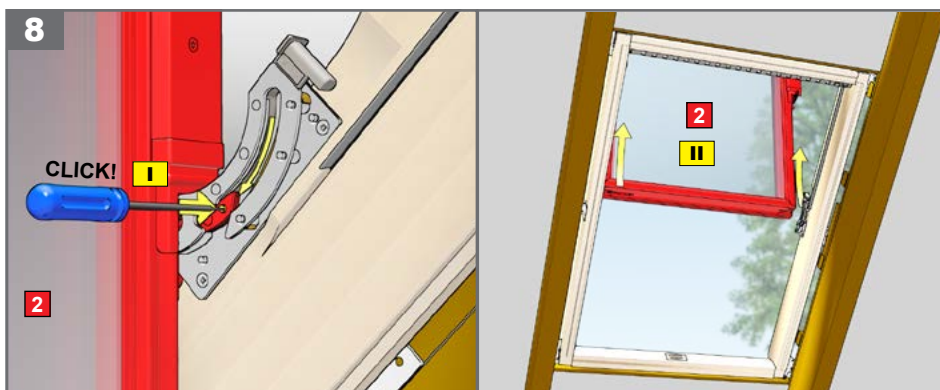
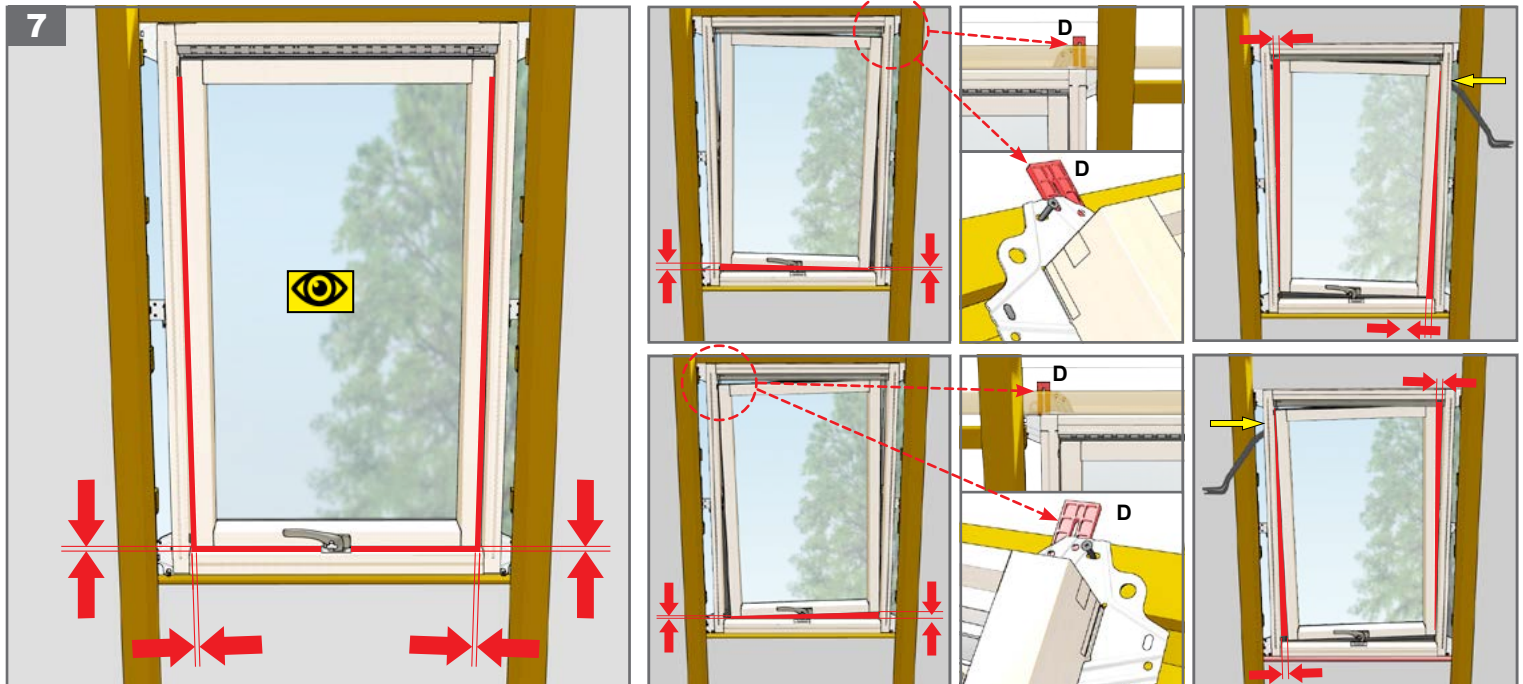
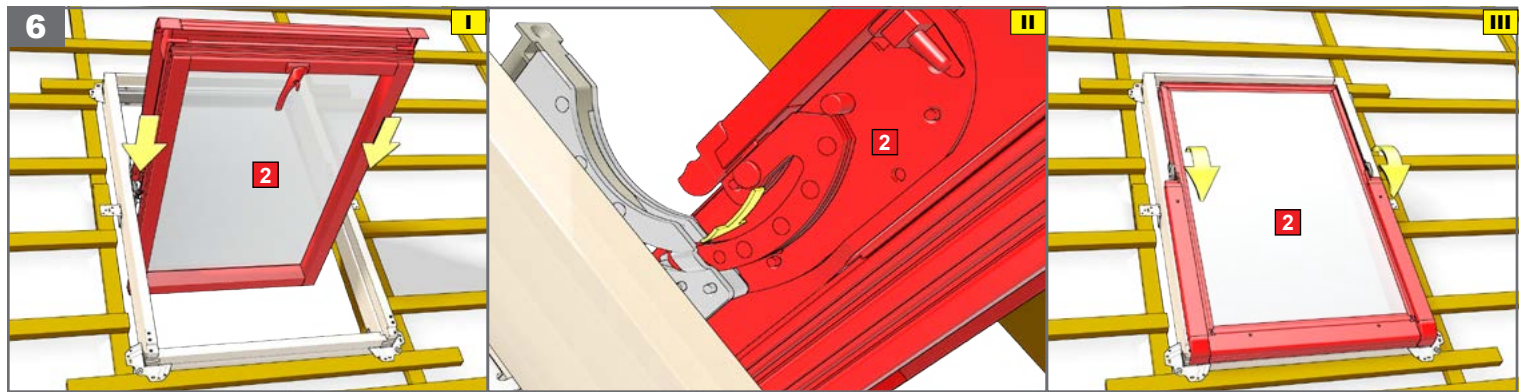
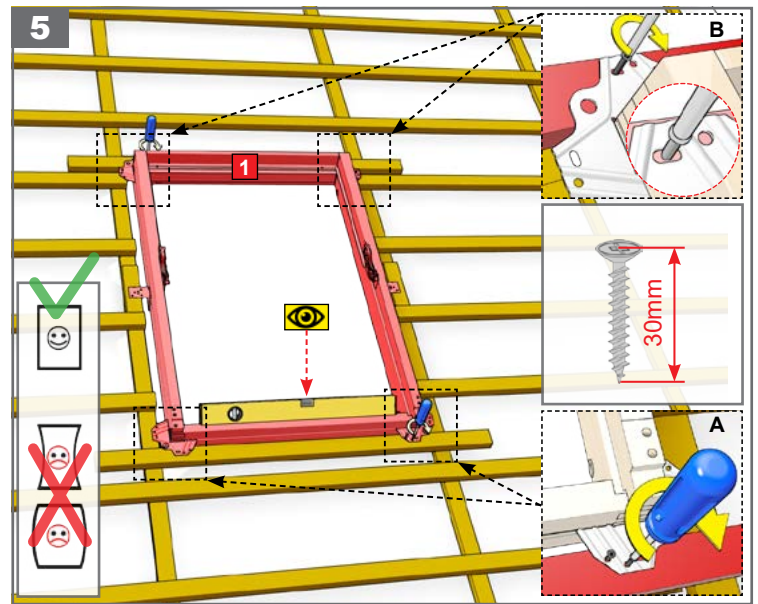
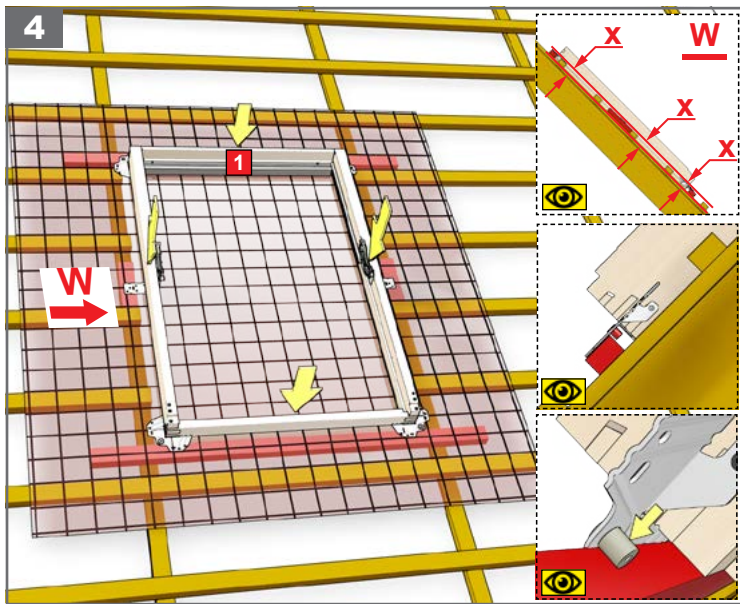

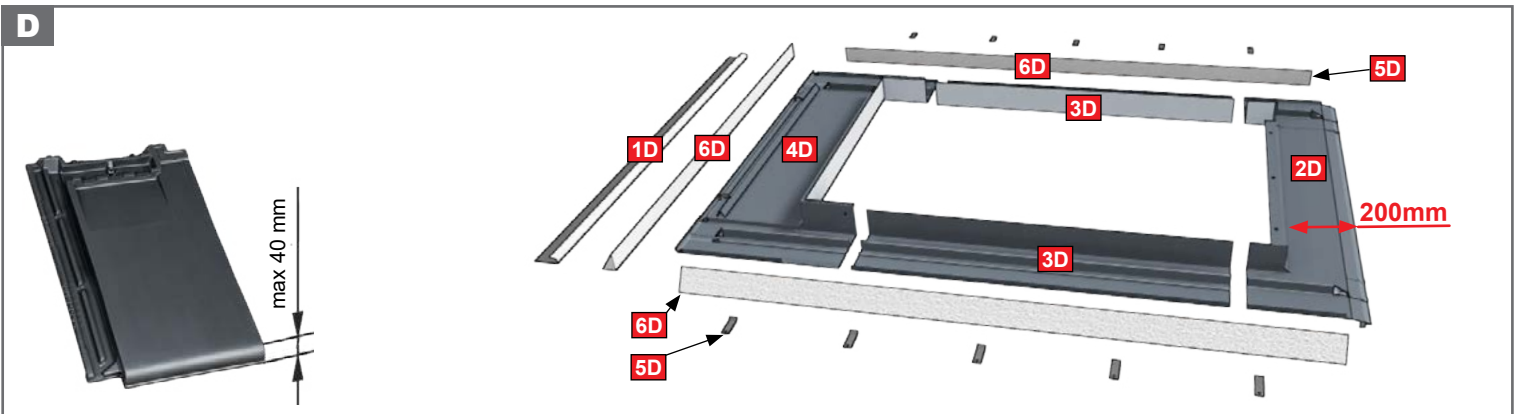
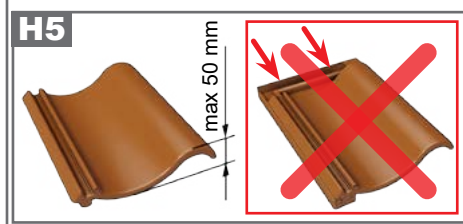
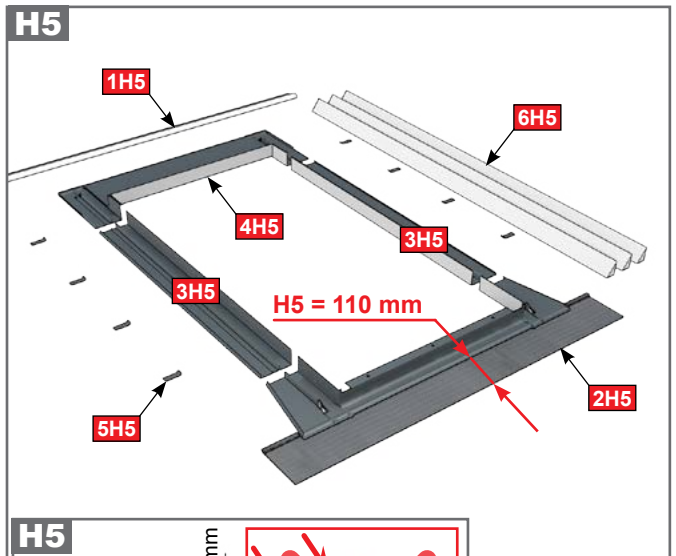
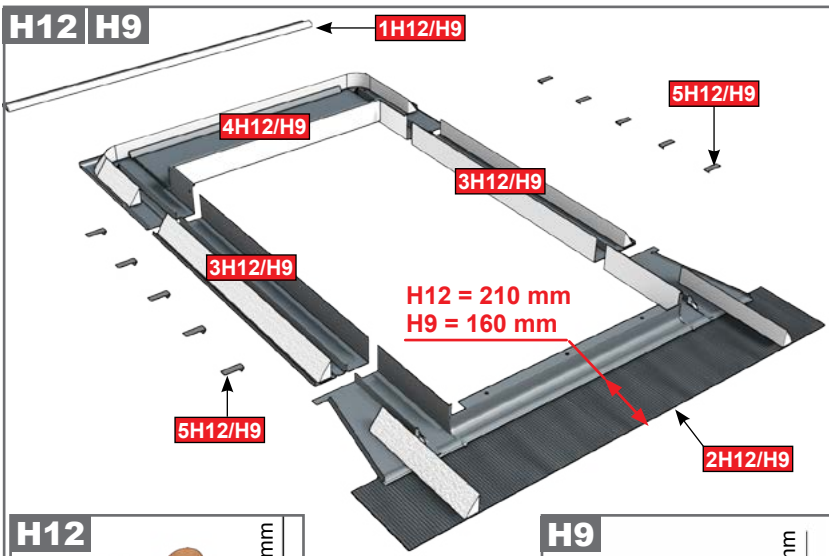
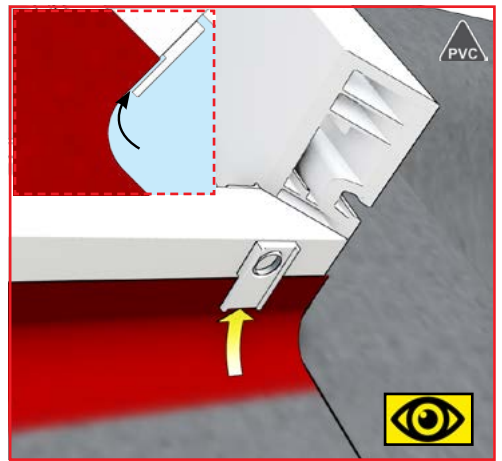
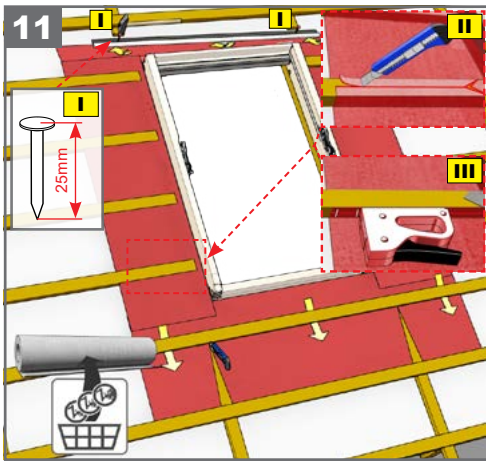
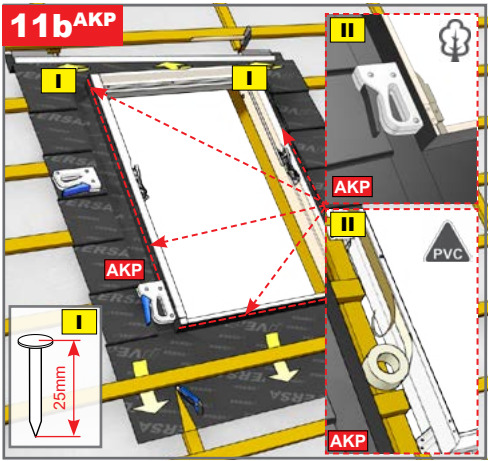
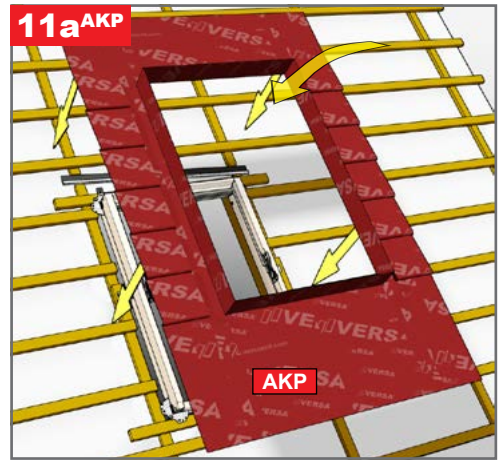
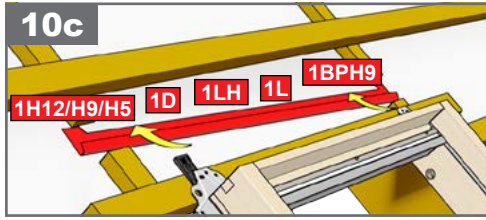
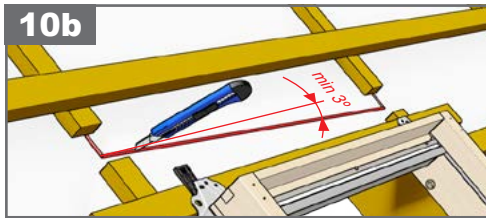
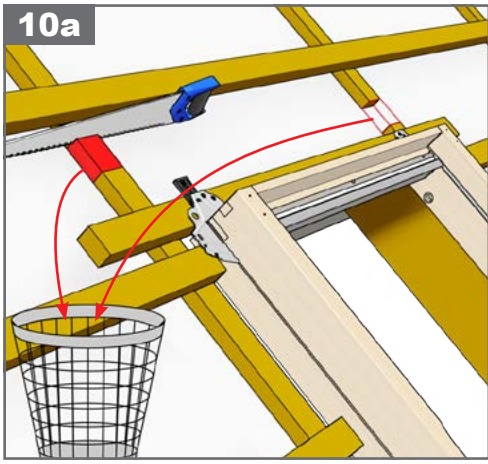

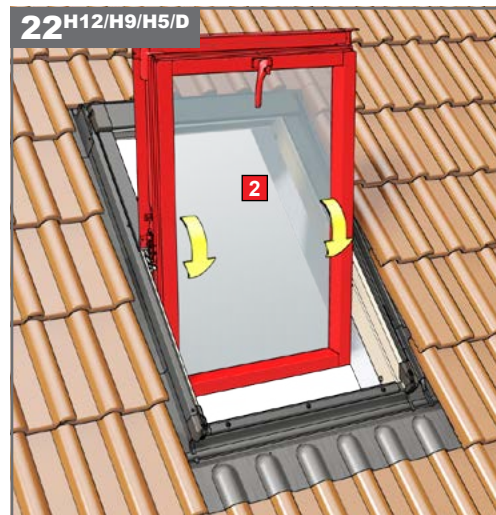
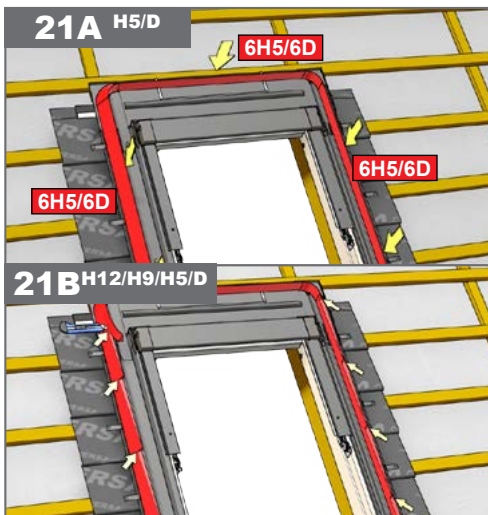
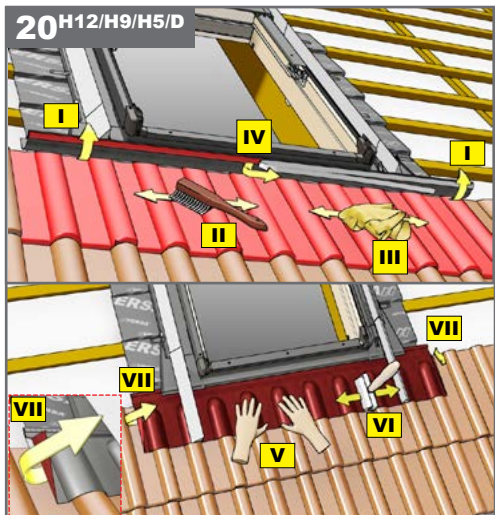
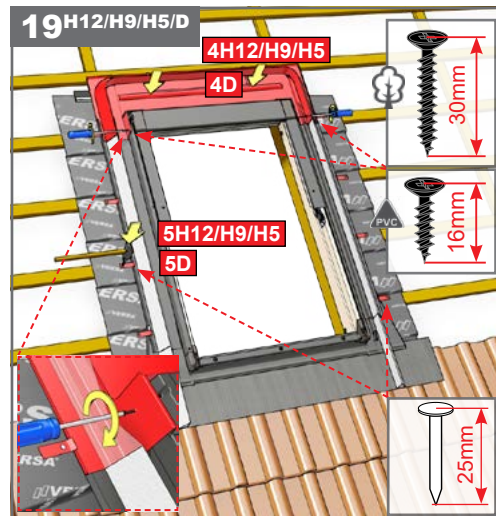
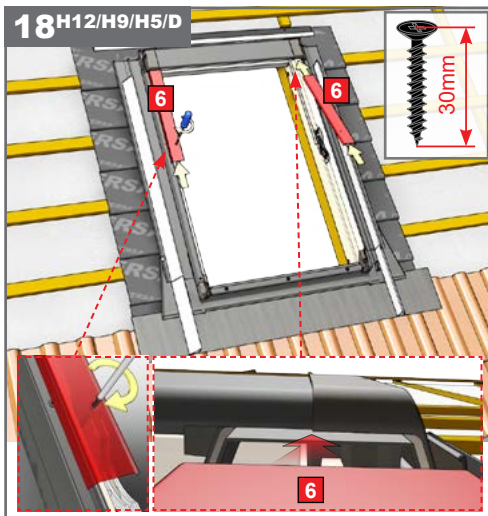
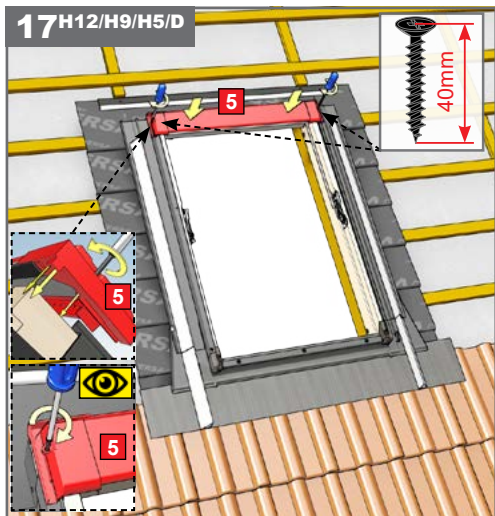
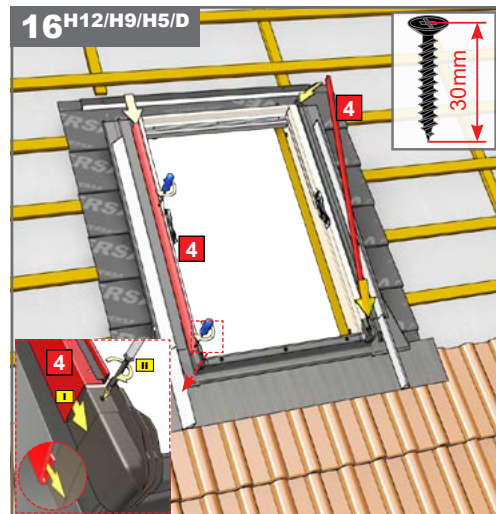
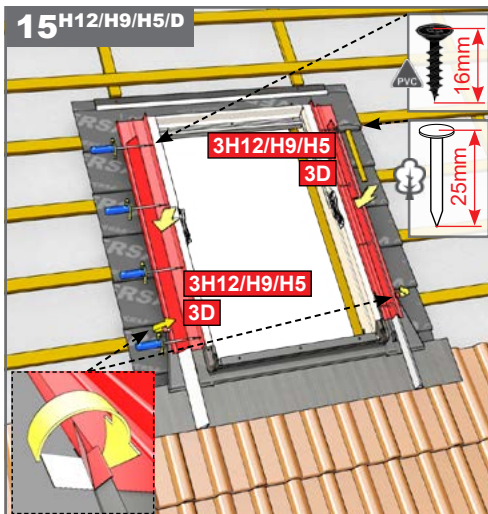
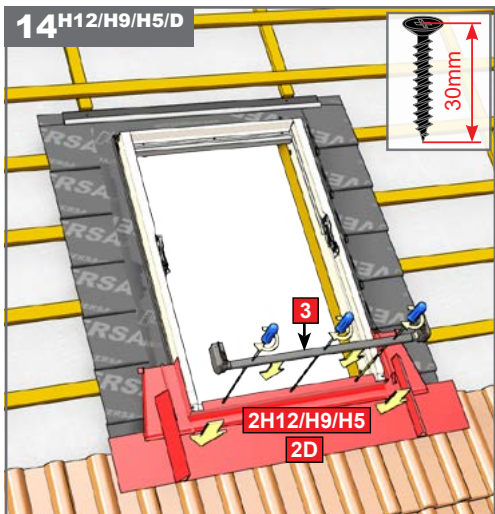
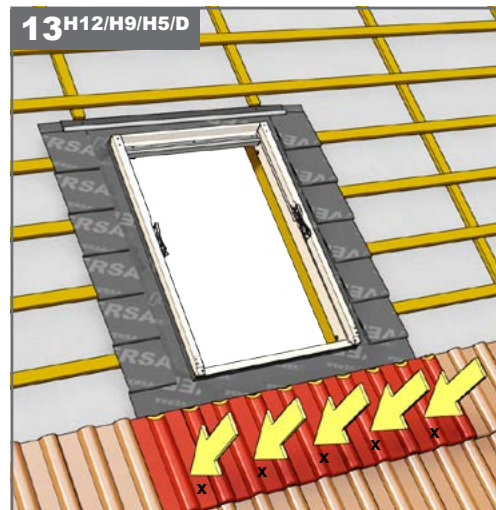
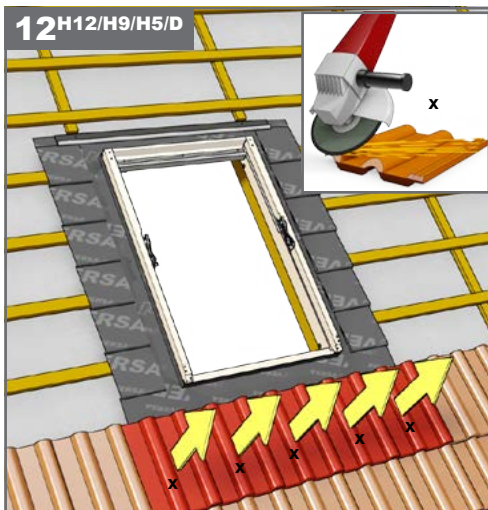
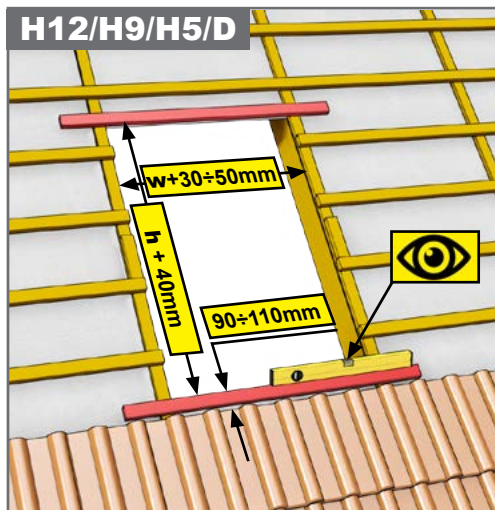

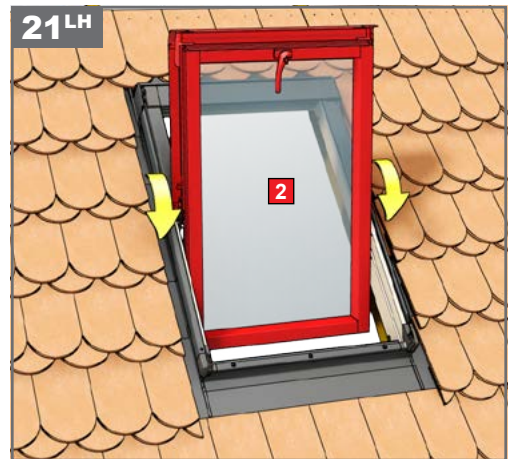
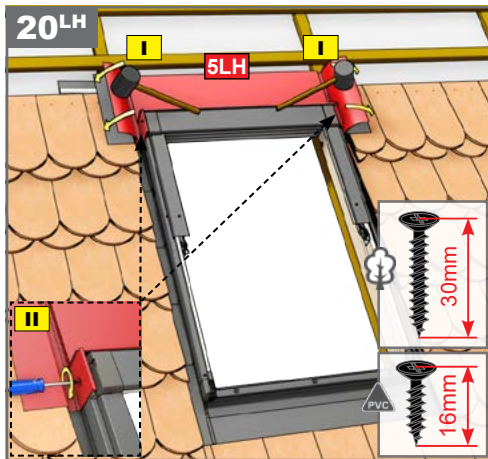
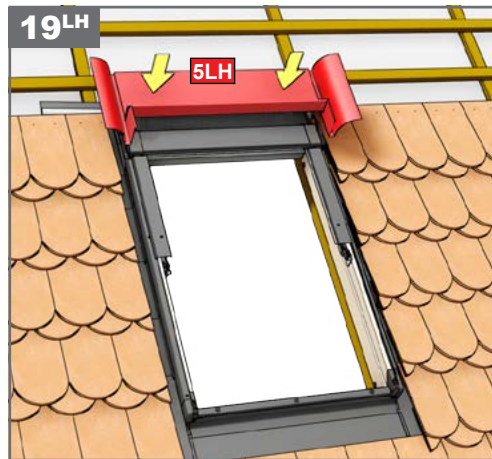
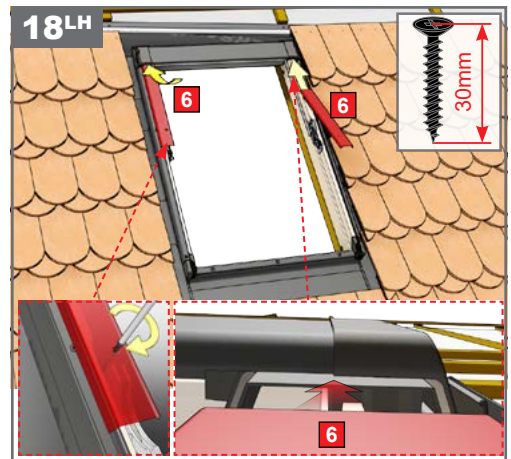
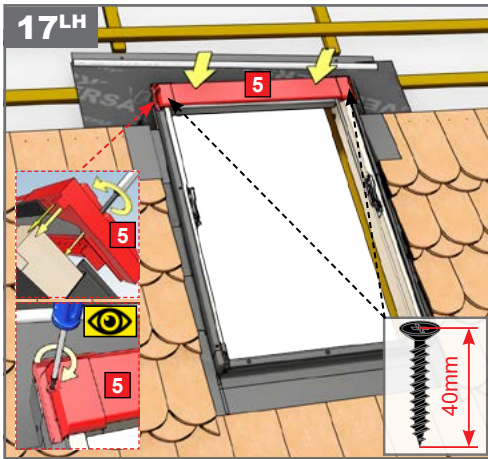
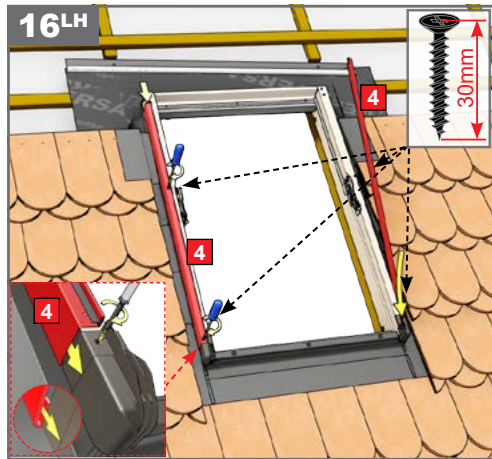
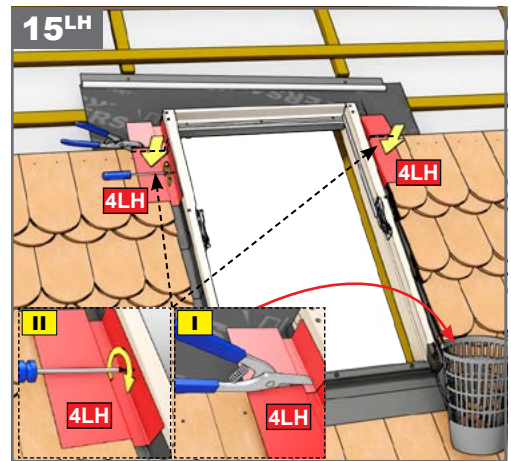
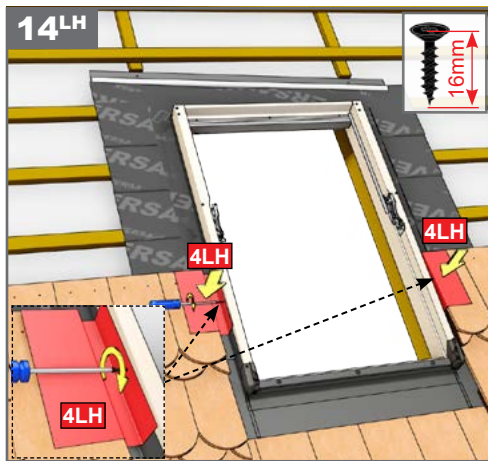
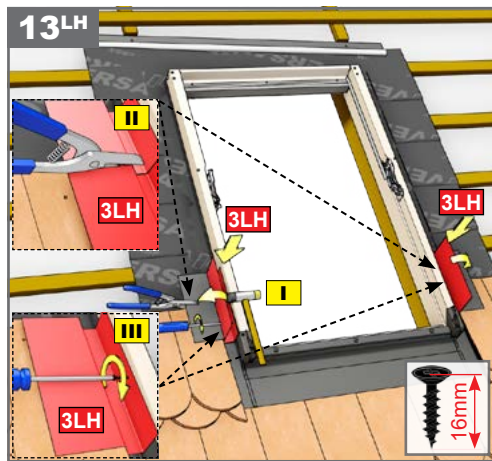
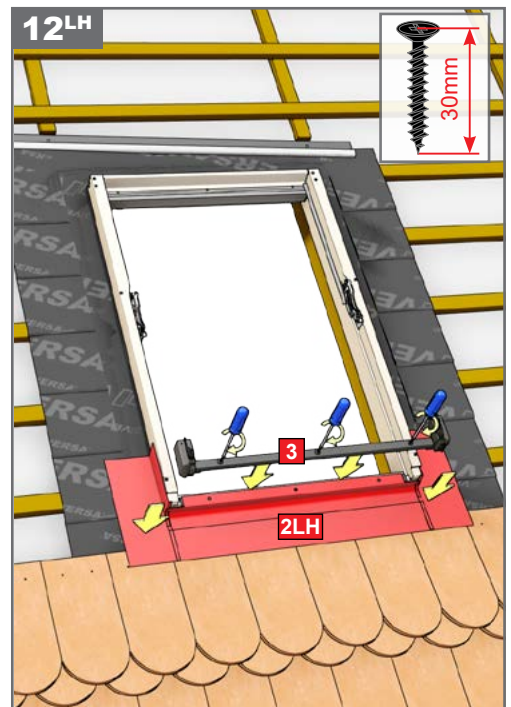
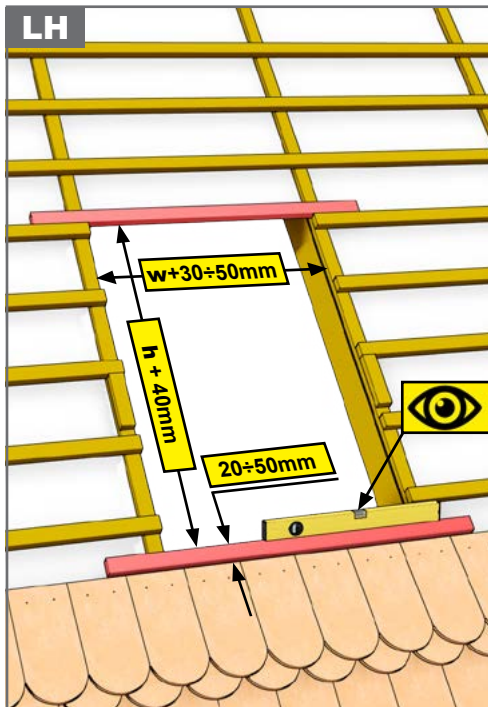
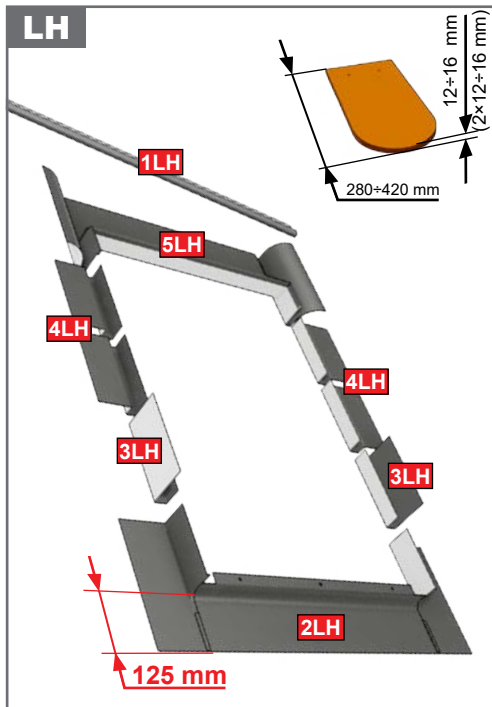

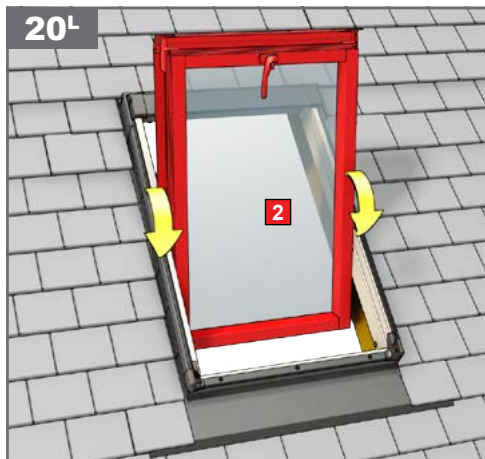
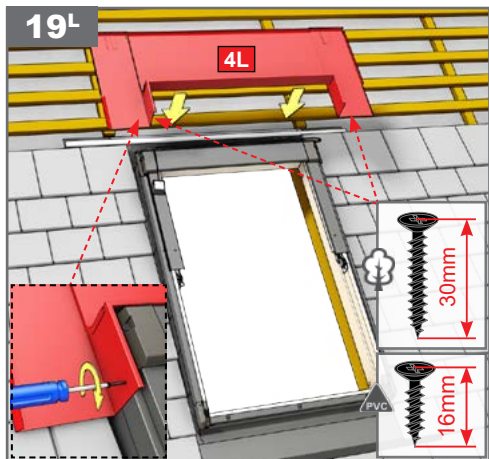
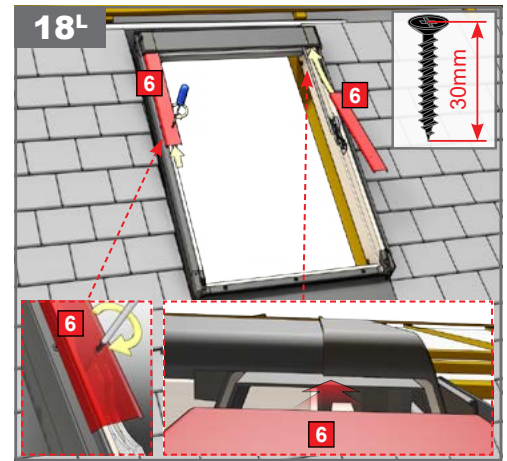
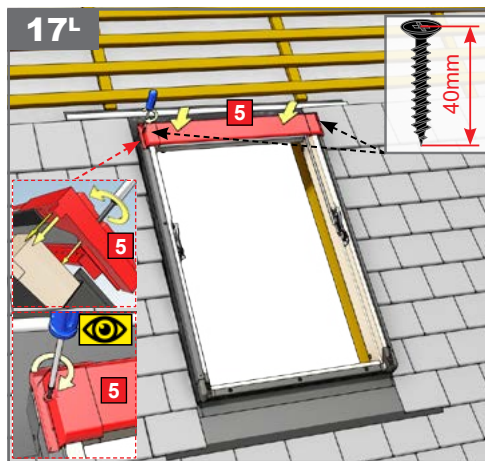
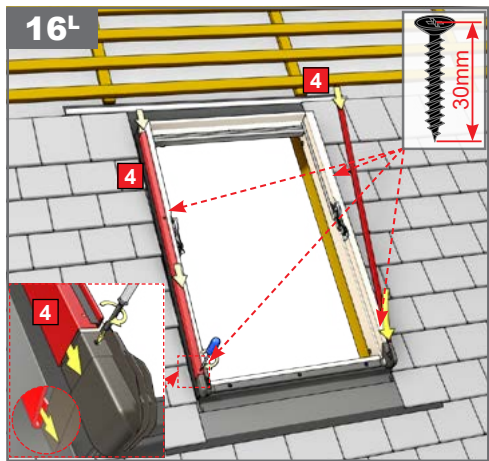
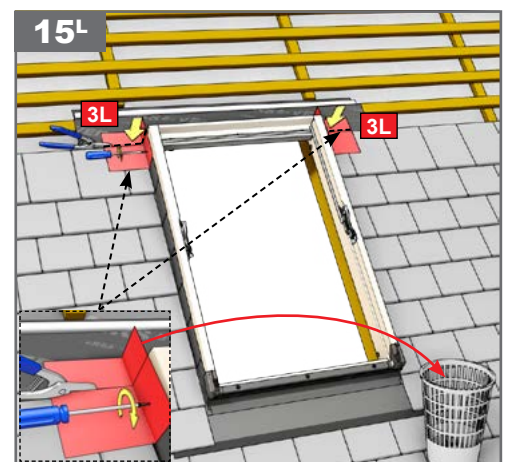
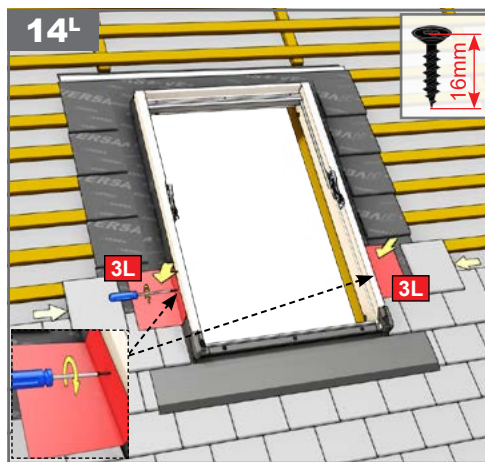
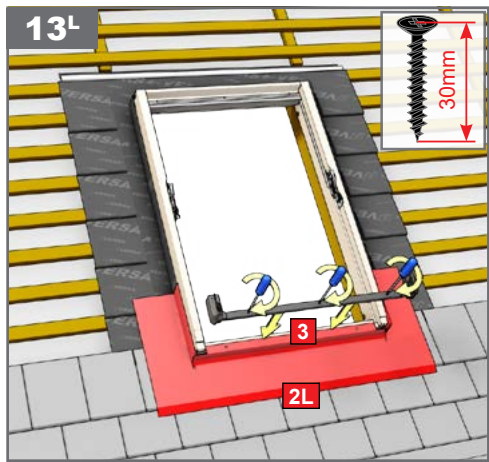
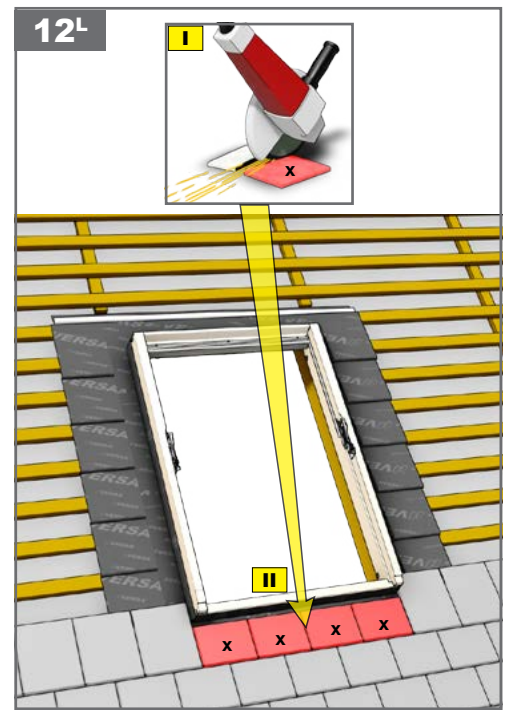
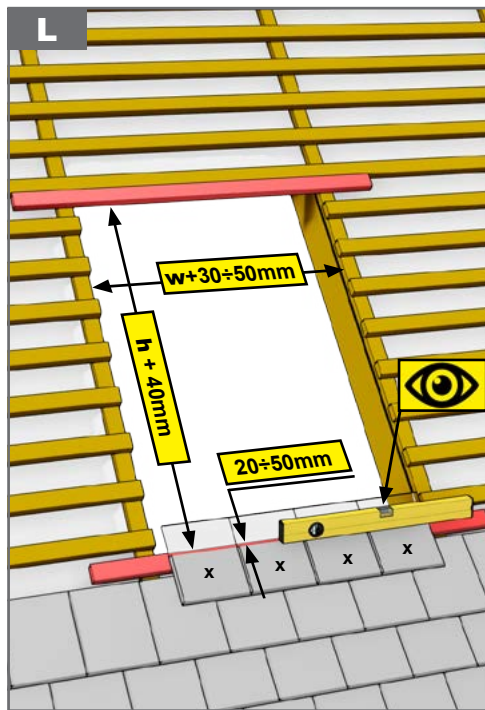
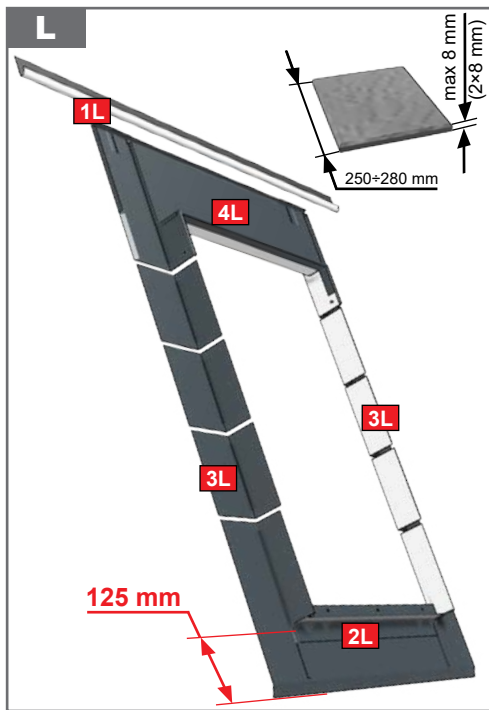

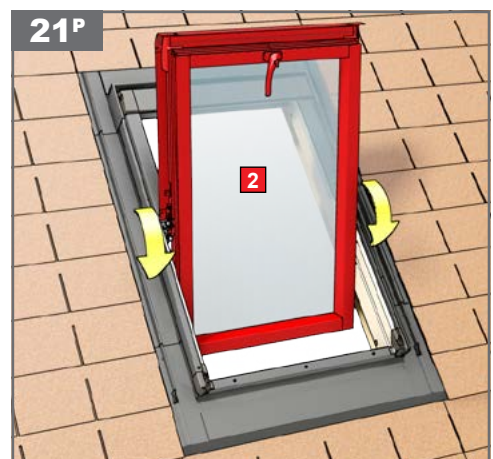
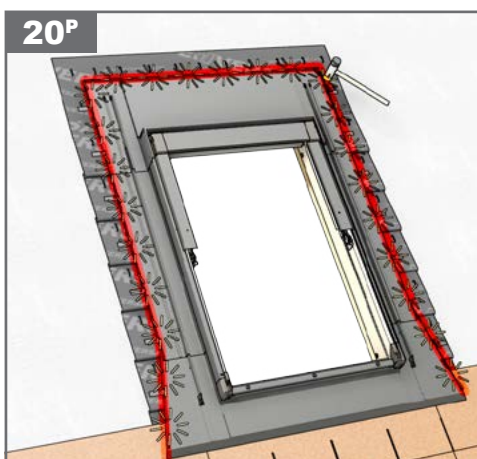
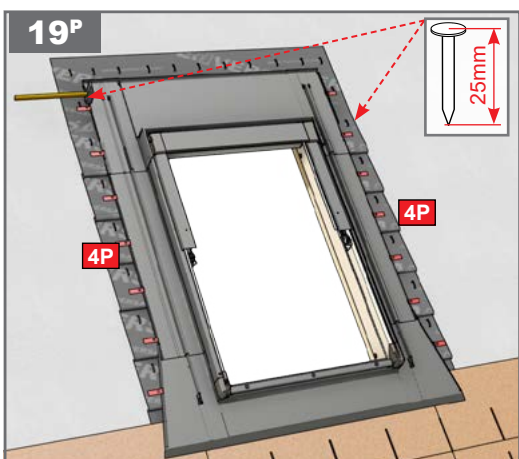
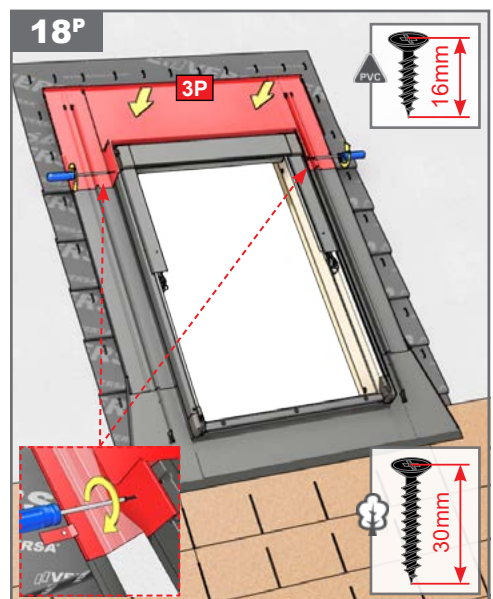
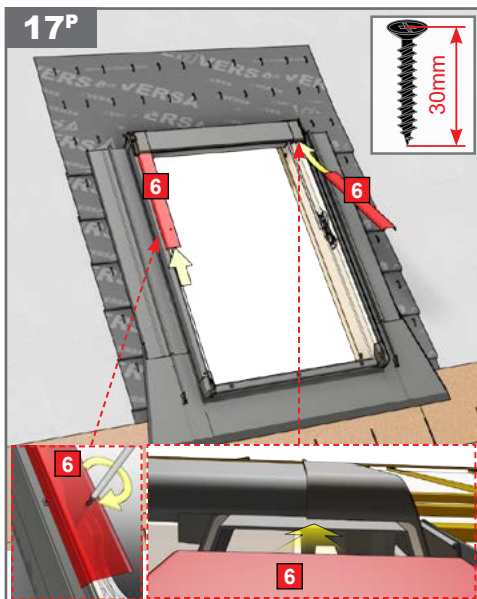
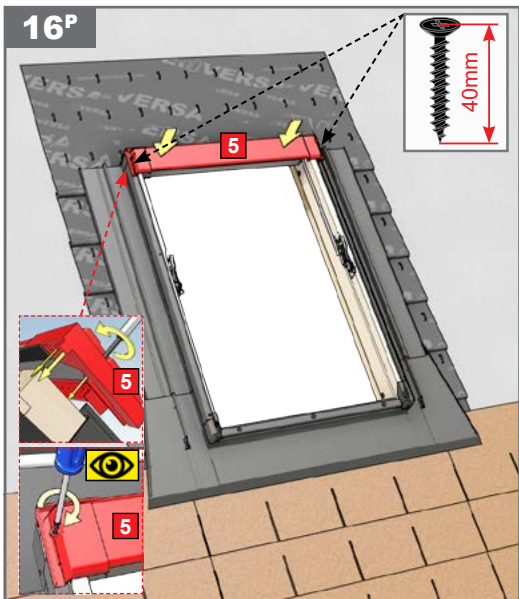
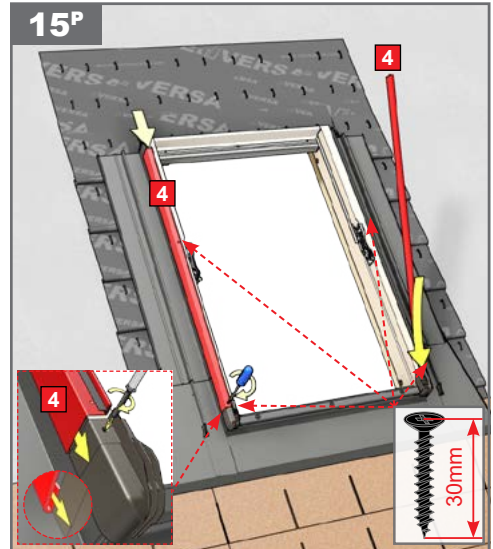
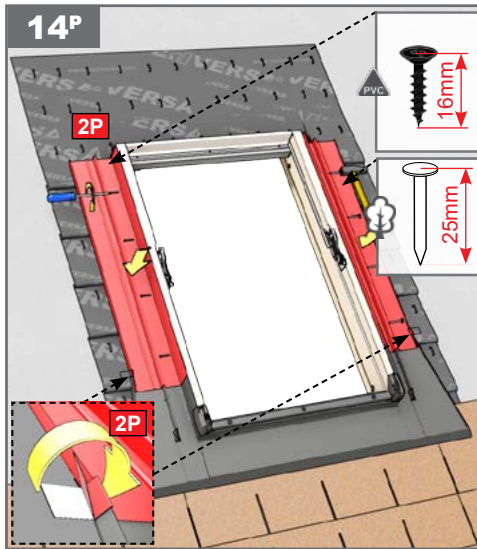
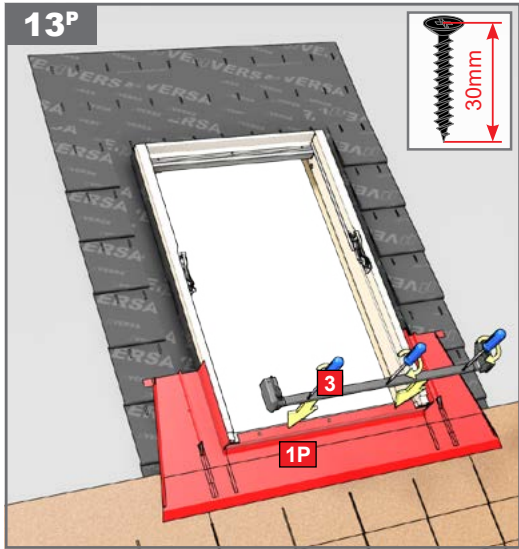
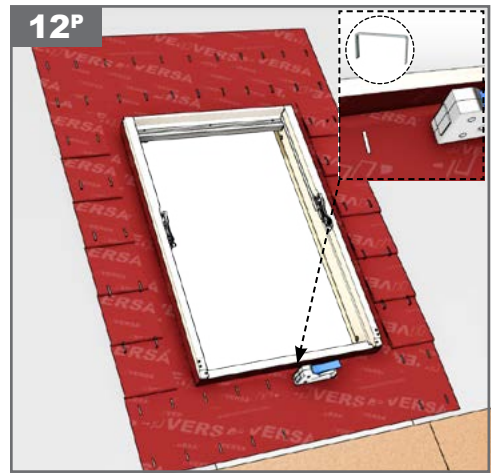
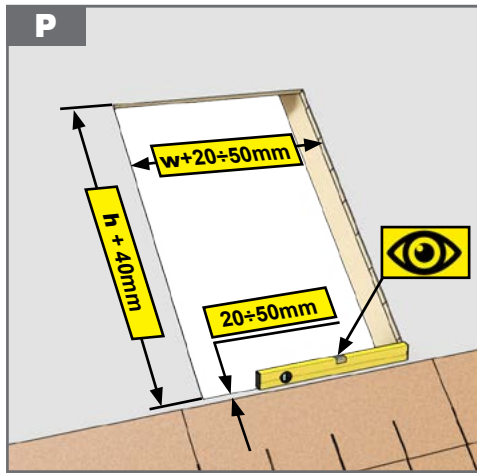
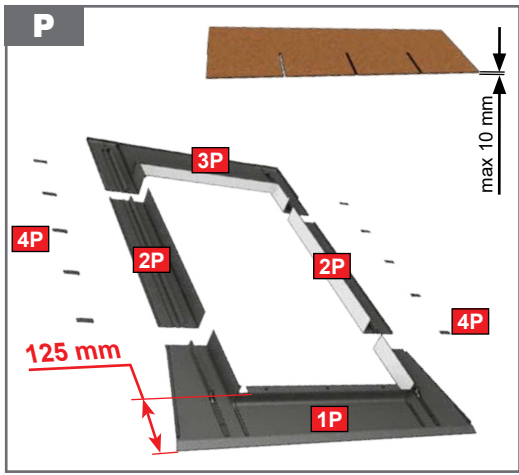

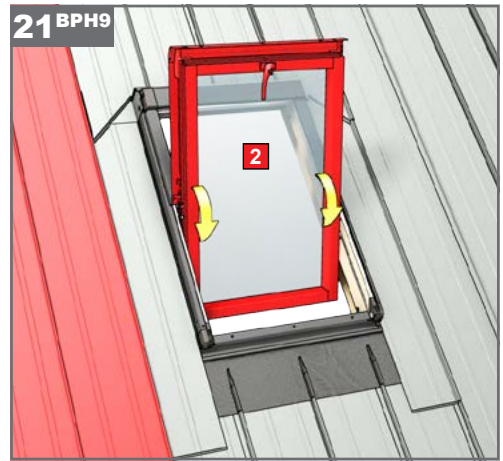
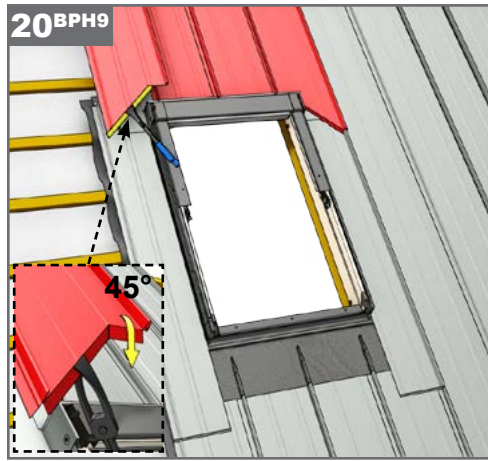
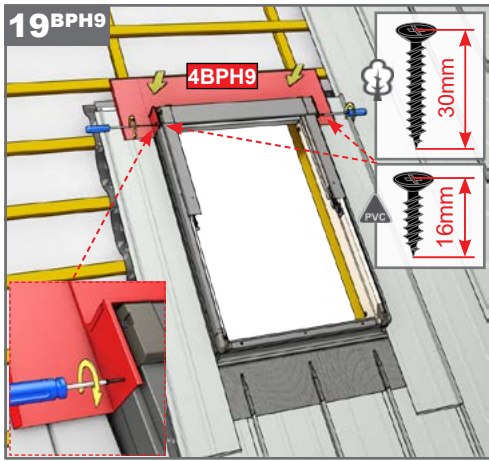
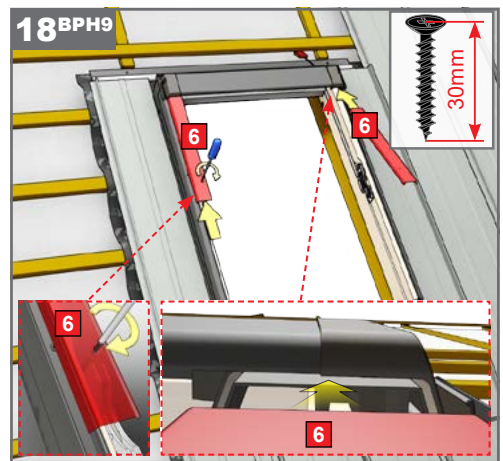
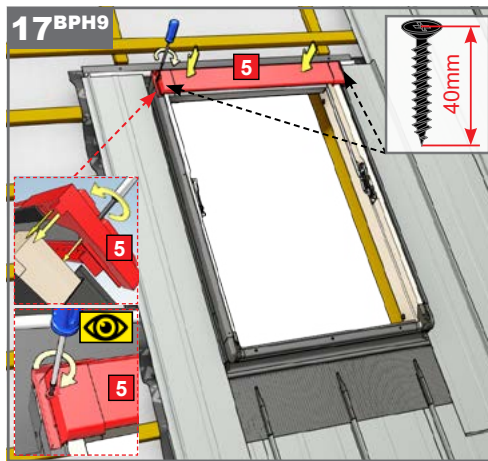
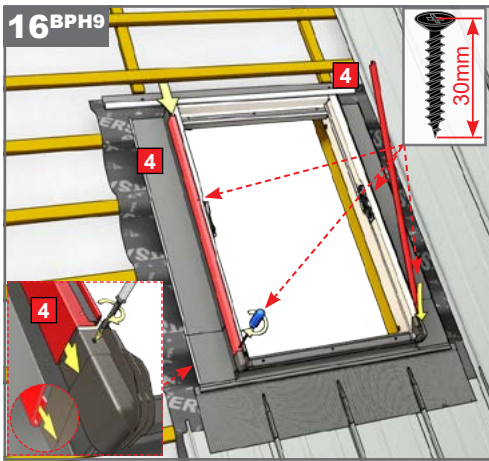
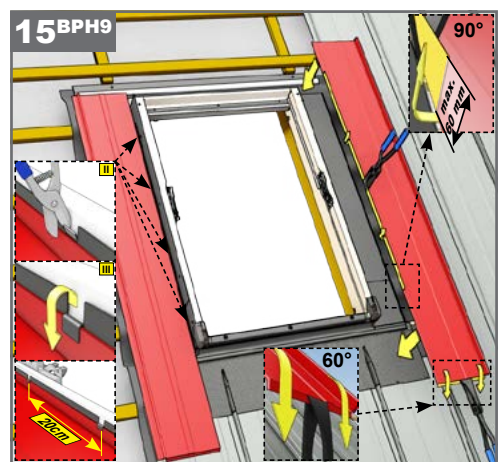
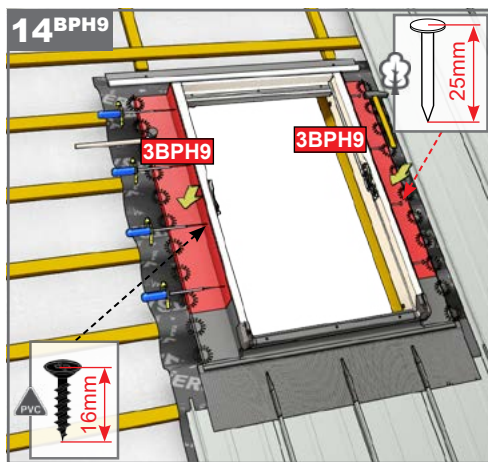
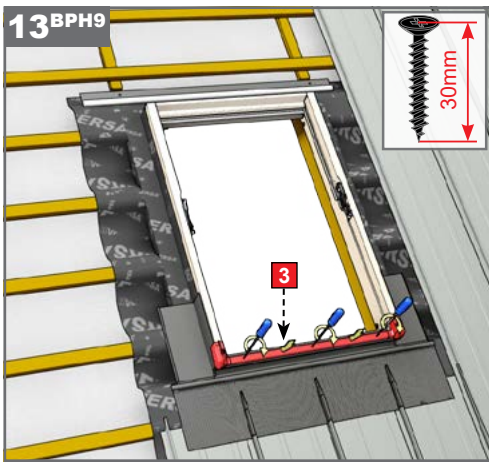
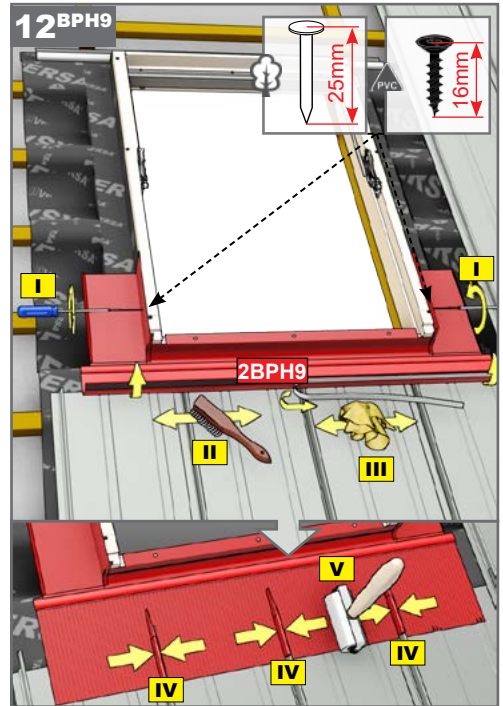
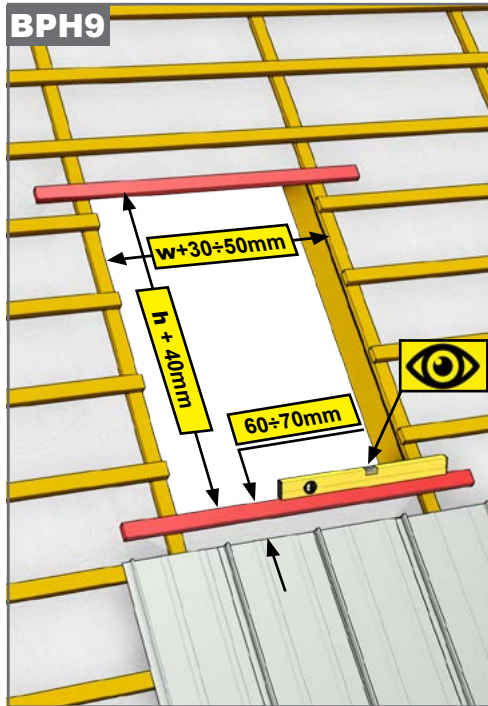
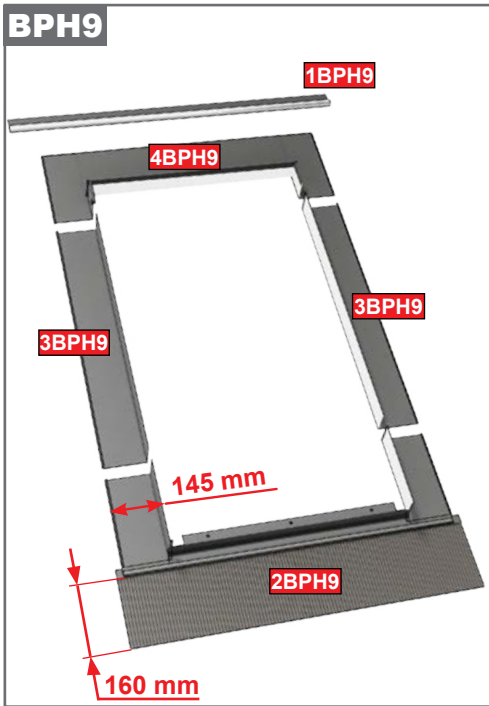

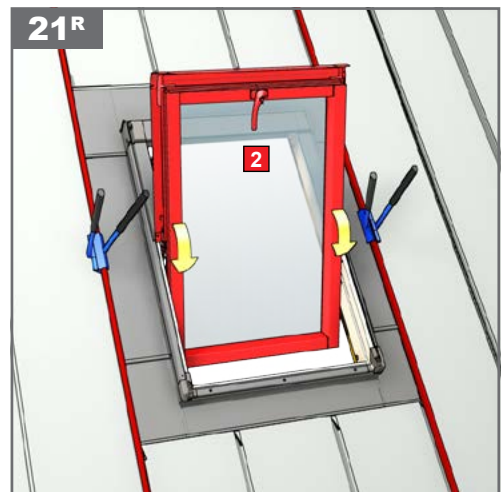
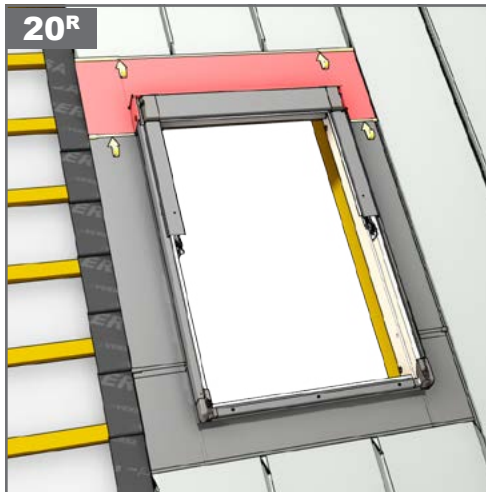
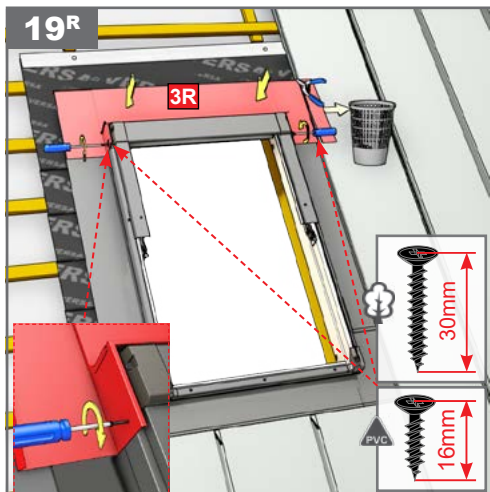
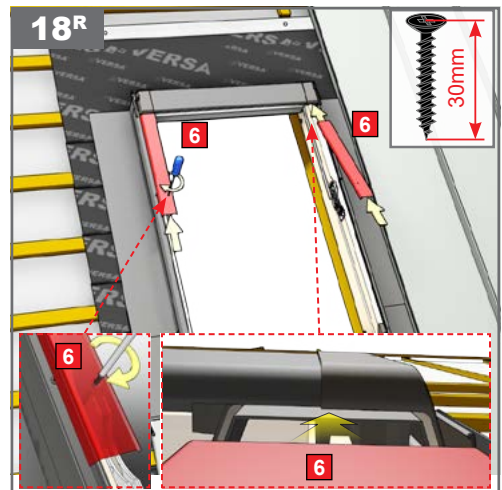
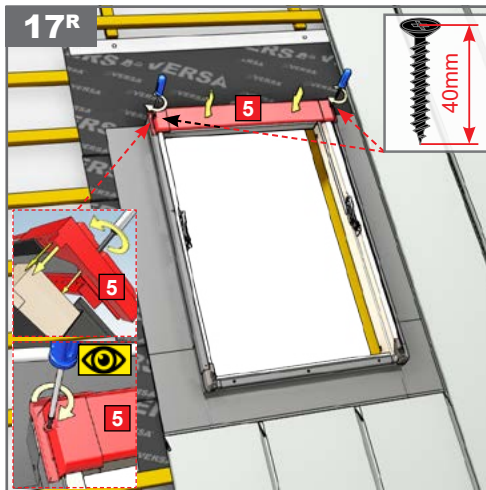
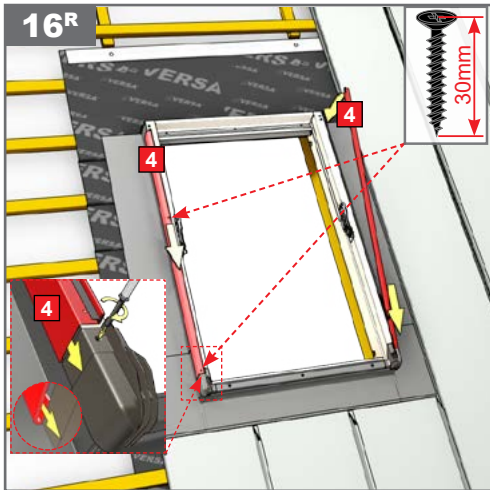
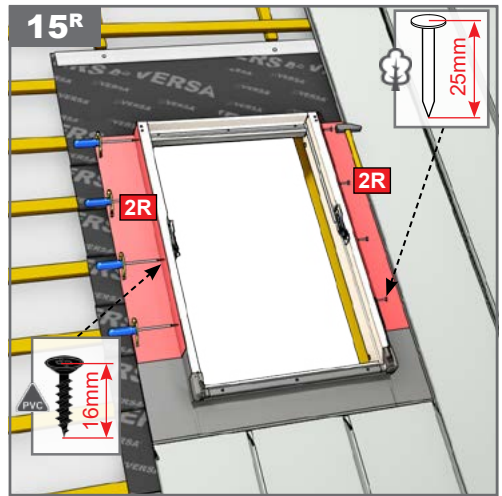
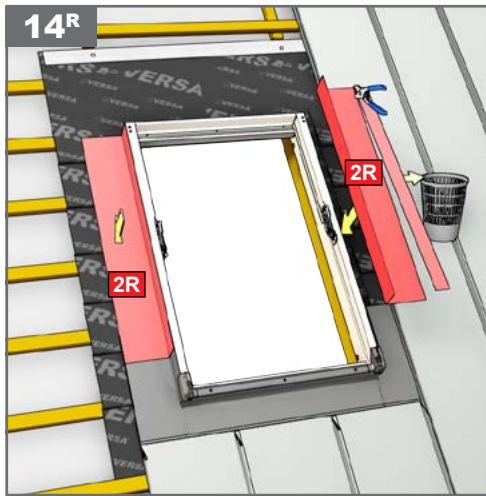
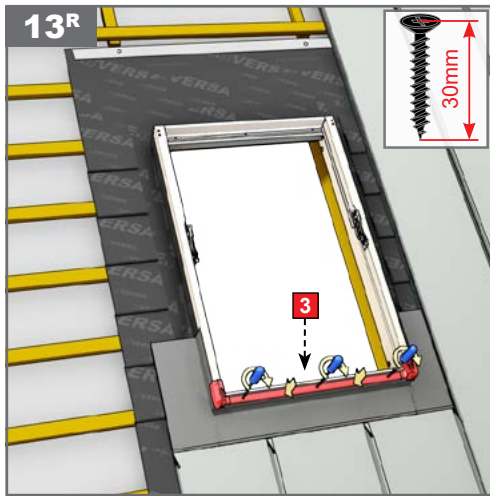
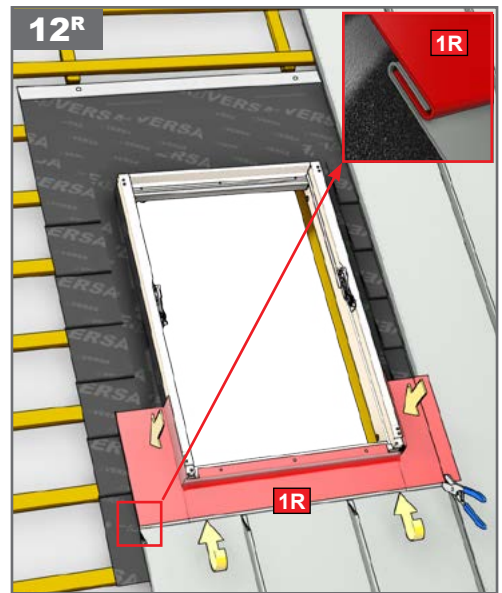
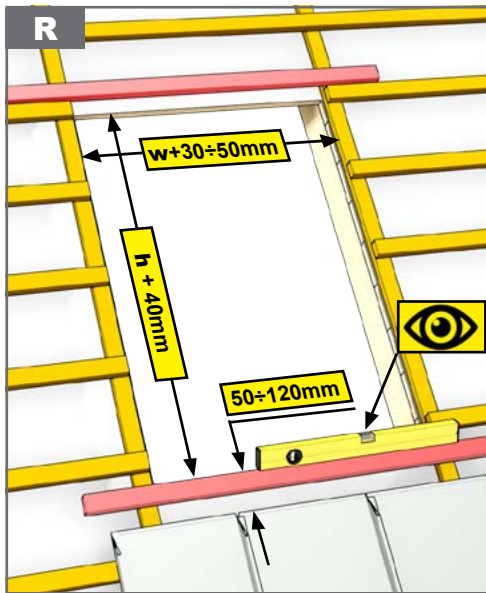
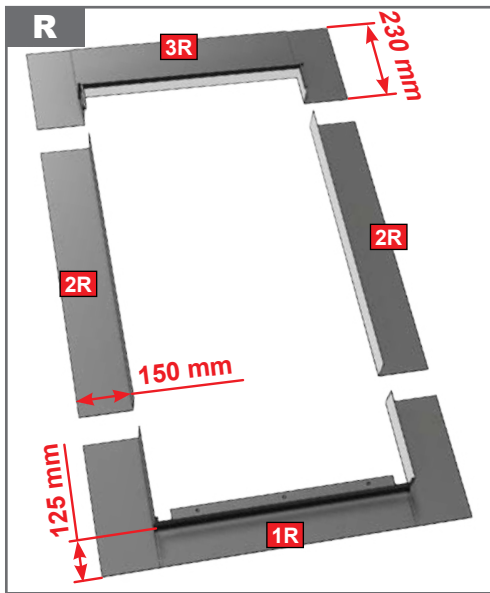

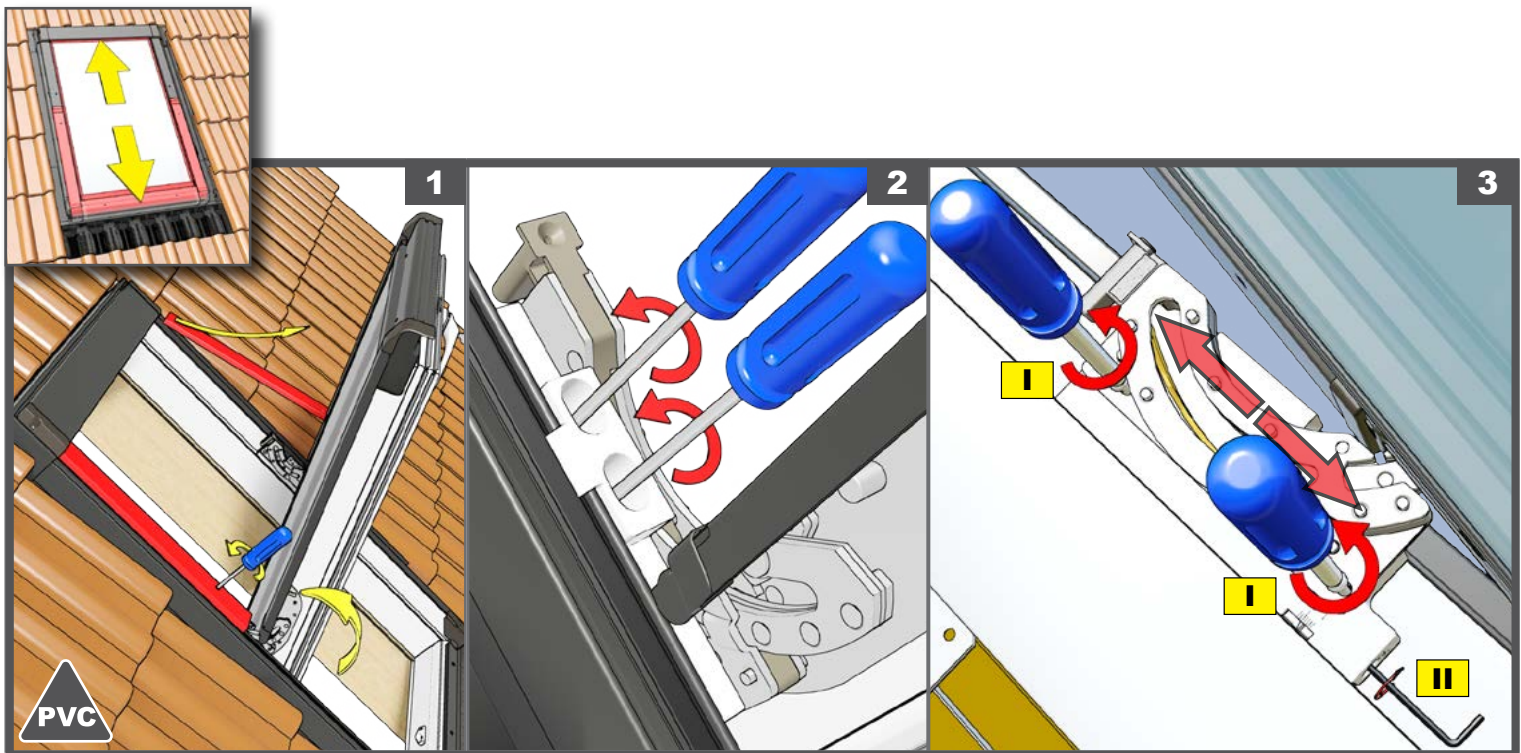

 **1 × YEAR**

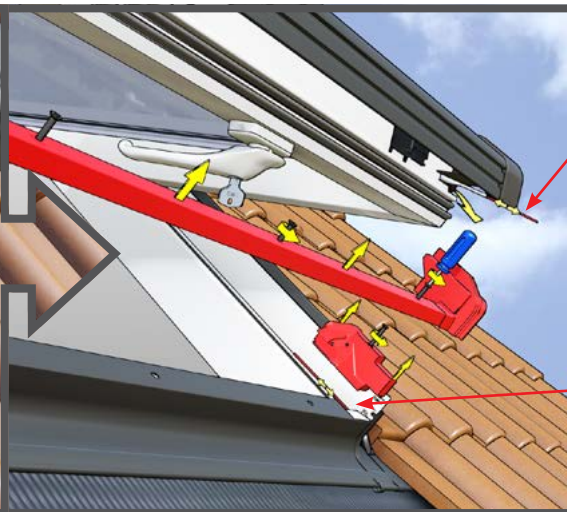
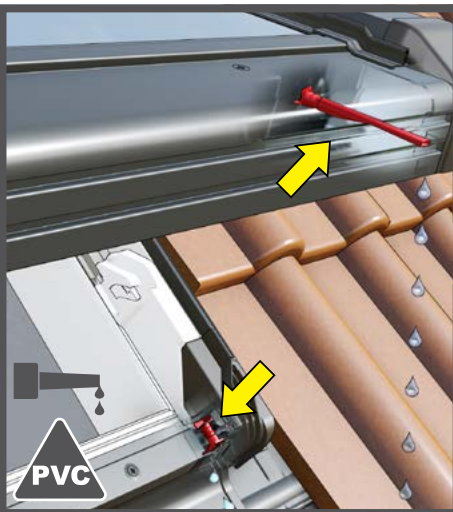
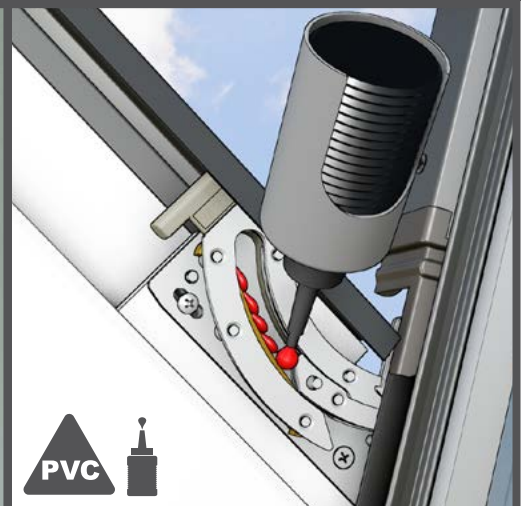
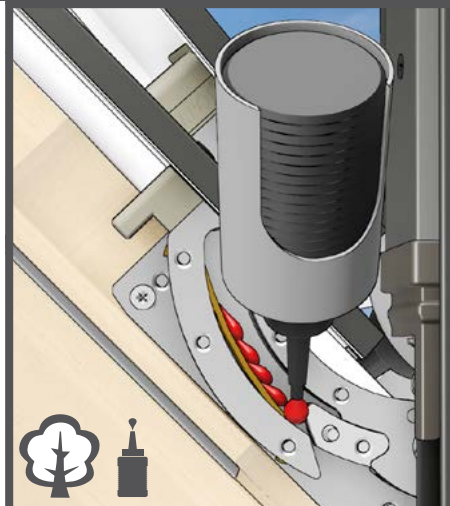
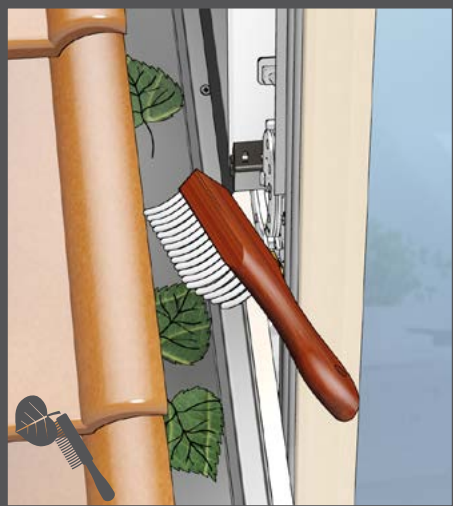

OKPOL®

OKPOL Sp. z o.o.

ul. Topolowa 24
49-318 Skarbimierz-Osiedle

e-mail: okpol@okpol.pl
e-mail: serwis@okpol.pl

Producent zastrzega, iż nie będzie ponosić żadnej odpowiedzialności za nieprzestrzeganie wymogów bezpieczeństwa oraz przepisów prawa jak również prawa budowlanego przez właściciela, użytkownika, montażystę oraz architekta.

The manufacturer reserves that it will not incur any liability for failure to comply with safety requirements and laws as well as construction law by the owner, operator, fitter and architect.